

KOBELCO

HYDRAULIC CRAWLER CRANE

CKL2600i

Model: CKL2600i



Max. Lifting Capacity: 260 t x 4.6 m
Max. Crane Boom Length: 91.4 m
Max. Fixed Jib Combination: 76.2 + 30.5 m
Max. Luffing Jib Combination: 61.0 + 61.0 m

CONFIGURATION

Crane Boom

Max. Lifting Capacity:
260 metric ton x 4.6 m
Max. Boom Length:
91.4 m



Long Boom

Max. Lifting Capacity:
47.1 metric ton x 12.8 m
Max. Boom Length:
91.4 m



Luffing Boom

Max. Lifting Capacity:
150 metric ton x 7.0 m
Max. Boom Length:
61.0 m

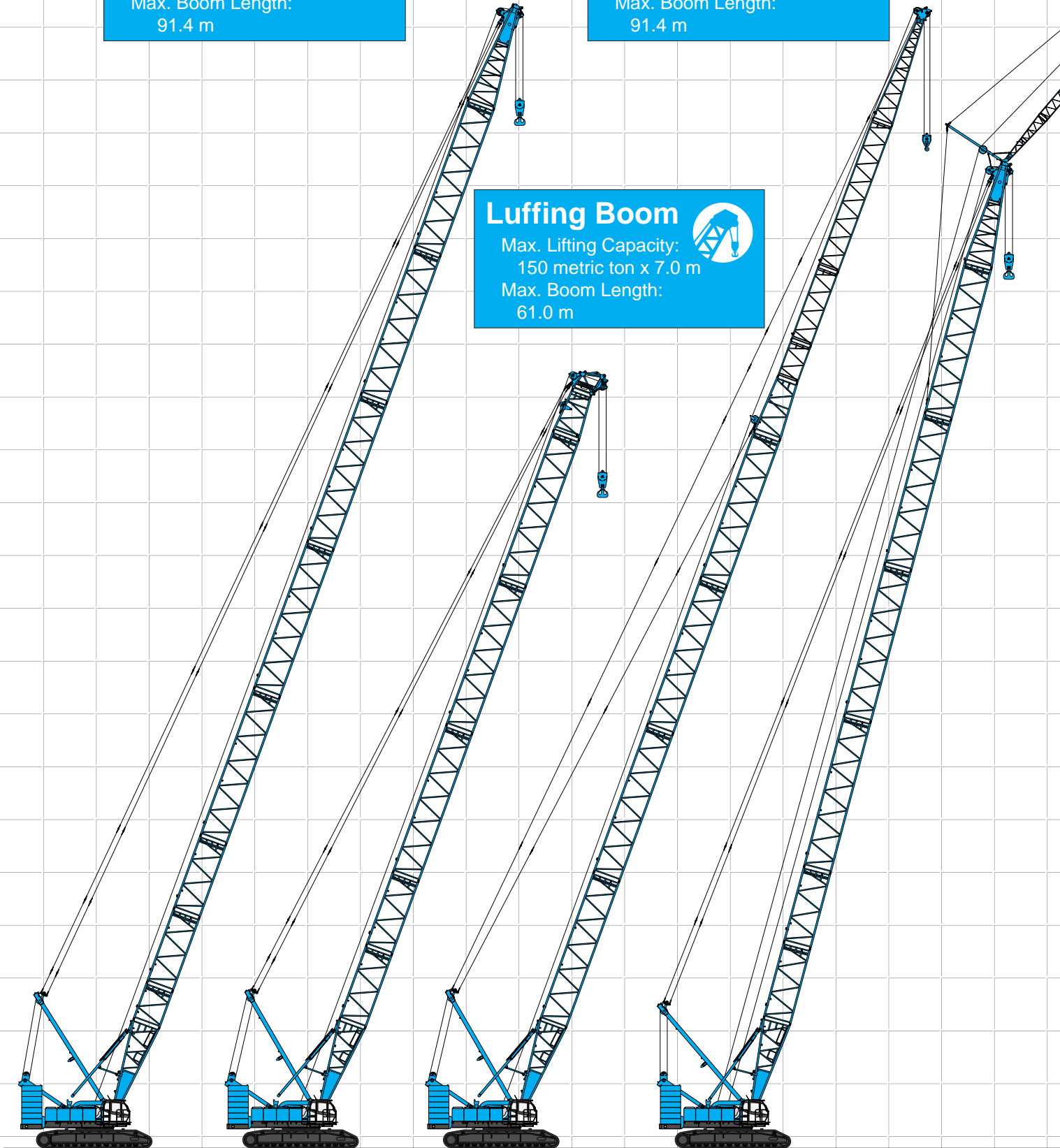

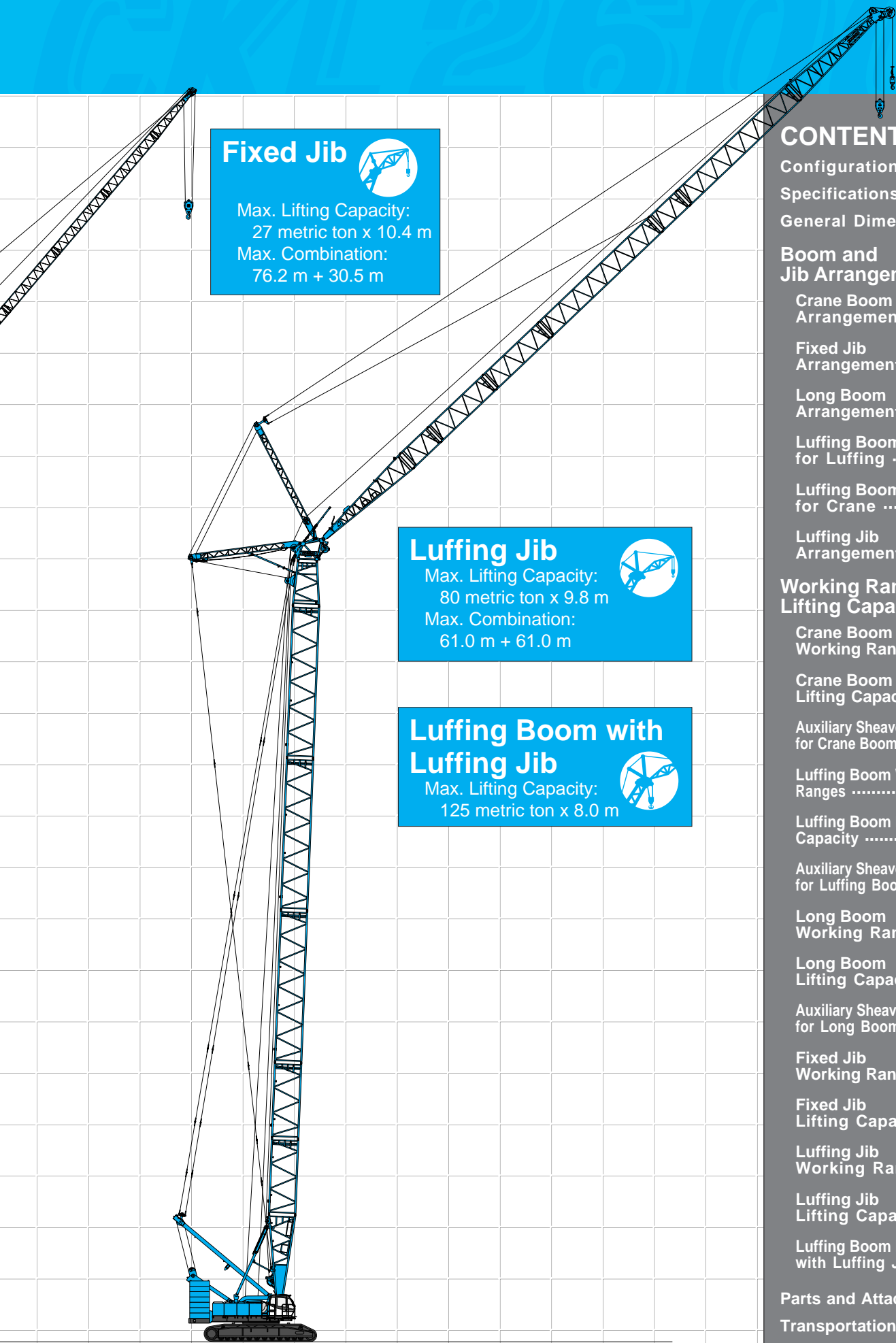

Fixed Jib 

Max. Lifting Capacity:
27 metric ton x 10.4 m
Max. Combination:
76.2 m + 30.5 m

Luffing Jib 

Max. Lifting Capacity:
80 metric ton x 9.8 m
Max. Combination:
61.0 m + 61.0 m

Luffing Boom with Luffing Jib 

Max. Lifting Capacity:
125 metric ton x 8.0 m

CONTENTS

- Configuration 1
- Specifications 3
- General Dimensions 5
- Boom and Jib Arrangements**
- Crane Boom Arrangements 7
- Fixed Jib Arrangements 8
- Long Boom Arrangements 8
- Luffing Boom Arrangements for Luffing 9
- Luffing Boom Arrangements for Crane 9
- Luffing Jib Arrangements 10
- Working Ranges and Lifting Capacities**
- Crane Boom Working Ranges 12
- Crane Boom Lifting Capacity 13
- Auxiliary Sheave Lifting Capacity for Crane Boom 14
- Luffing Boom Working Ranges 15
- Luffing Boom Lifting Capacity 16
- Auxiliary Sheave Lifting Capacity for Luffing Boom 17
- Long Boom Working Ranges 18
- Long Boom Lifting Capacity 19
- Auxiliary Sheave Lifting Capacity for Long Boom 20
- Fixed Jib Working Ranges 21
- Fixed Jib Lifting Capacities 22
- Luffing Jib Working Ranges 25
- Luffing Jib Lifting Capacities 27
- Luffing Boom Lifting Capacities with Luffing Jib 33
- Parts and Attachments 35
- Transportation Plan 37
- Self-Removal Device 38

SPECIFICATIONS



Power Plant

Model: Hino diesel engine P11C-UN

Type: Water-cooled, direct fuel injection, with turbocharger
Complies with NRMM (Europe) Stage IIIA and US EPA Tier III.

Displacement: 10.520 liters

Rated Power: 247 kW at 2,000 min⁻¹ {rpm} (ISO)

Max. torque: 1,300 N·m/1,500 min⁻¹

Cooling system: Liquid, recirculating bypass

Starter: 24 V/6.0 kW

Radiator: Corrugated type core, thermostatically controlled

Air cleaner: Dry type with replaceable paper element

Throttle: Electric throttle control, twist grip type

Fuel filter: Replaceable paper element

Batteries: Two 12V, 150Ah/20HR capacity batteries, series connected.

Fuel tank capacity: 370 liters



Hydraulic System

Four variable displacement piston pumps are driven by heavy-duty pump drive. Two of variable displacement pumps are used in the main hook hoist circuit, auxiliary hook hoist circuit, jib hoist circuit and each propel circuit. One of the other two pumps is used in the boom hoist circuit, and the other is used in the swing circuit.

Control: Full-flow hydraulic control system for infinitely variable pressure to front and rear drums, boom hoist drum and propel. Controls respond instantly to the touch, delivering smooth function operation.

Cooling: Oil-to-air heat exchanger (plate-fin type)

Filtration: Full-flow and bypass type with replaceable element

Electrical system: All wiring corded for easy servicing, individual fused branch circuits.

Max. relief valve pressure:

Load hoist, boom hoist and propel system:

31.9 MPa {325 kgf/cm²}

Swing system: 27.5 MPa {280 kgf/cm²}

Control system: 5.4 MPa {55 kgf/cm²}

Reservoir capacity: 600 liters



Boom Hoisting System

Powered by a hydraulic motor through a planetary reducer.

Brake: A spring-set, hydraulically released multiple-disc brake is mounted on the boom hoist motor and operated through a counter-balance valve.

Drum lock: External ratchet for locking drum.

Drum: Double drum, grooved for 26 mm dia. wire rope.

Line speed: Double line on first drum layer

Hoisting/Lowering: 22 to 2 m/min x 2

Diameter of wire ropes

Boom guy line: 38 mm

Boom hoist reeving: 16 parts of 26 mm dia. high strength wire rope

Boom backstops: Required for all boom lengths



Load Hoist System

Front and rear drums for load hoist powered by a hydraulic variable plunger motors, driven through planetary reducers.

Negative Brake: A spring-set, hydraulically released multiple-disc brake is mounted on the hoist motor and operated through a counter-balance valve. (Positive free fall brake is optional item.)

Drum lock: External ratchet for locking drum

Drums:

Front drum:

617.1 mm P.C.D. x 833.7 mm Lg. wide drum, grooved for 25 mm wire rope. Rope capacity is 480 m working length and 600 m storage length.

Rear drum:

617.4 mm P.C.D. x 833.7 mm Lg. wide drum, grooved for 25 mm wire rope. Rope capacity is 390 m working length and 600 m storage length.

Note: Rope lengths listed above denote drum capacity and may differ from actual rope lengths supplied when machinery is shipped.

Line speed: Single line on the first drum layer

Hoisting/Lowering: 100 to 3 m/min

Line Pull (Single-line):

Rated line pull: 132 kN {13.5 tf}



Swing System

Swing unit is powered by hydraulic motor driving spur gears through planetary reducers (2 sets), the swing system provides 360° rotation.

Swing parking brakes: A spring-set, hydraulically released multiple-disc brake is mounted on swing motor.

Swing circle: Single-row ball bearing with an integral internally cut swing gear.

Swing lock: Manually, four position lock for transportation

Swing speed: 2.0 min⁻¹ {rpm}



Upper Structure

Torsion-free precision machined upper frame. All components are located clearly and service friendly. Engine with low noise level. Complies with EC Directive 2000/14/EC.

Counterweight: 90.0 ton



Cab & Control

Totally enclosed, full vision cab with safety glass, fully adjustable, high backed seat with a head-rest and armrests, and intermittent wiper and window washer (skylight and front window).

Cab fittings:

Air conditioner, convenient compartment (for tool), cup holder, ashtray, cigarette lighter, sun visor, roof blind, tinted glass, floor mat, foot-rest, shoe tray

Controls:

Four adjustable levers for front drum, rear drum, boom drum and swing controls, and boom hoist pedal.



Lower Structure

Steel-welded carbody with axles. Crawler assemblies are designed with quick disconnect feature for individual removal as a unit from axles. Crawler belt tension is maintained by hydraulic jack force on the track-adjusting bearing block.

Carbody weight: 24.0 ton

Crawler drive: Independent hydraulic propel drive is built into each crawler side frame. Each drive consists of a hydraulic motor propelling a driving tumbler through a planetary gear box. Hydraulic motor and gear box are built into the crawler side frame within the shoe width.

Crawler brakes: Spring-set, hydraulically released parking brakes are built into each propel drive.

Steering mechanism: A hydraulic propel system provides both skid steering (driving one track only) and counter-rotating steering (driving each track in opposite directions).

Track rollers: Sealed track rollers for maintenance-free operation.

Shoes (flat): 68 shoes, 1,220 mm wide each crawler
(Optional 1,330 mm shoe is available)

Max. travel speed: 1.1/0.7 km/h

Max. gradeability: 30%



Weight

Including upper and lower machine, 90.0 ton counterweight and 24.0 ton carbody weight, basic boom (or basic boom + basic jib), hook, and other accessories.

Specification	Weight	Ground pressure
Crane boom	Approx. 214 ton, 109 kPa	{1.11 kgf/cm ² }
Fixed jib	Approx. 215 ton, 109 kPa	{1.11 kgf/cm ² }
Luffing jib	Approx. 223 ton, 114 kPa	{1.16 kgf/cm ² }



Attachment

Boom and Jib:

Welded lattice construction using tubular, high-tensile steel chords with pin connections between sections.

Boom and Jib Length

	Min. Length (Min. Combination)	Max. Length (Max. Combination)
Crane Boom	15.2 m	91.4 m
Luffing Boom	15.2 m	61.0 m
Long Boom	64.0 m	91.4 m
Fixed Jib	27.4 m + 12.2 m	76.2 m + 30.5 m
Luffing Jib	21.3 m + 21.3 m	61.0 m + 61.0 m

Main Specifications (Model: CKL2600i)

Crane Boom	
Max. Lifting Capacity	260 t/4.6 m
Max. Length	91.4 m
Luffing Boom	
Max. Lifting Capacity	150 t/7.0 m
Max. Length	61.0 m
Long Boom	
Max. Lifting Capacity	47.1 t/12.8 m
Max. Length	91.4 m
Fixed Jib	
Max. Lifting Capacity	27 t/10.4 m
Max. Length	30.5 m
Max. Combination	76.2 m + 30.5 m
Luffing Jib	
Max. Lifting Capacity	80 t/9.8 m
Jib Length	21.3 m ~ 61.0 m
Max. Combination	61.0 m + 61.0 m
Luffing Angle	63° ~ 88°
Main & Aux. Winch	
Max. Line Speed	100 m/min (1st layer)
Rated Line Pull (Single Line)	132 kN {13.5 tf}
Wire Rope Diameter	25.4 mm
Wire Rope Length	480 m (Main) 390 m (Aux.)
Brake Type	Spring set hydraulically released (Negative)
Free-Fall Brake Type	Wet-type multiple disc brake (Optional)

Working Speed

Swing Speed	2.0 min ⁻¹ {2.0 rpm}
Travel Speed	1.1/0.7 km/h

Power Plant

Model	Hino P11C-UN
Engine Output	247 kW/2,000 min ⁻¹ {rpm}
Fuel Tank Capacity	370 liters

Hydraulic System

Main Pumps	4 variable displacement
Max. Pressure	31.9 MPa {325 kgf/cm ² }
Hydraulic Tank Capacity	600 liters

Self-Removal Device

	Standard
--	----------

Weight

Operating Weight*	Approx. 214 t
Ground Pressure*	109 kPa {1.11 kgf/cm ² }
Counterweight	90.0 t (Upper), 24.0 t (Lower)
Transport Weight**	Approx. 46.0 t

* Including upper and lower machine, 90.0 ton counterweight and 24.0 ton carbody weight, basic boom, hook, and other accessories.

** Base machine with trans-lifter, main and aux. winches (non-free fall) including wire rope, and boom hoist winch including wire rope.

Units are SI units. { } indicates conventional units.

GENERAL DIMENSIONS

Crane Boom

(Unit: mm)

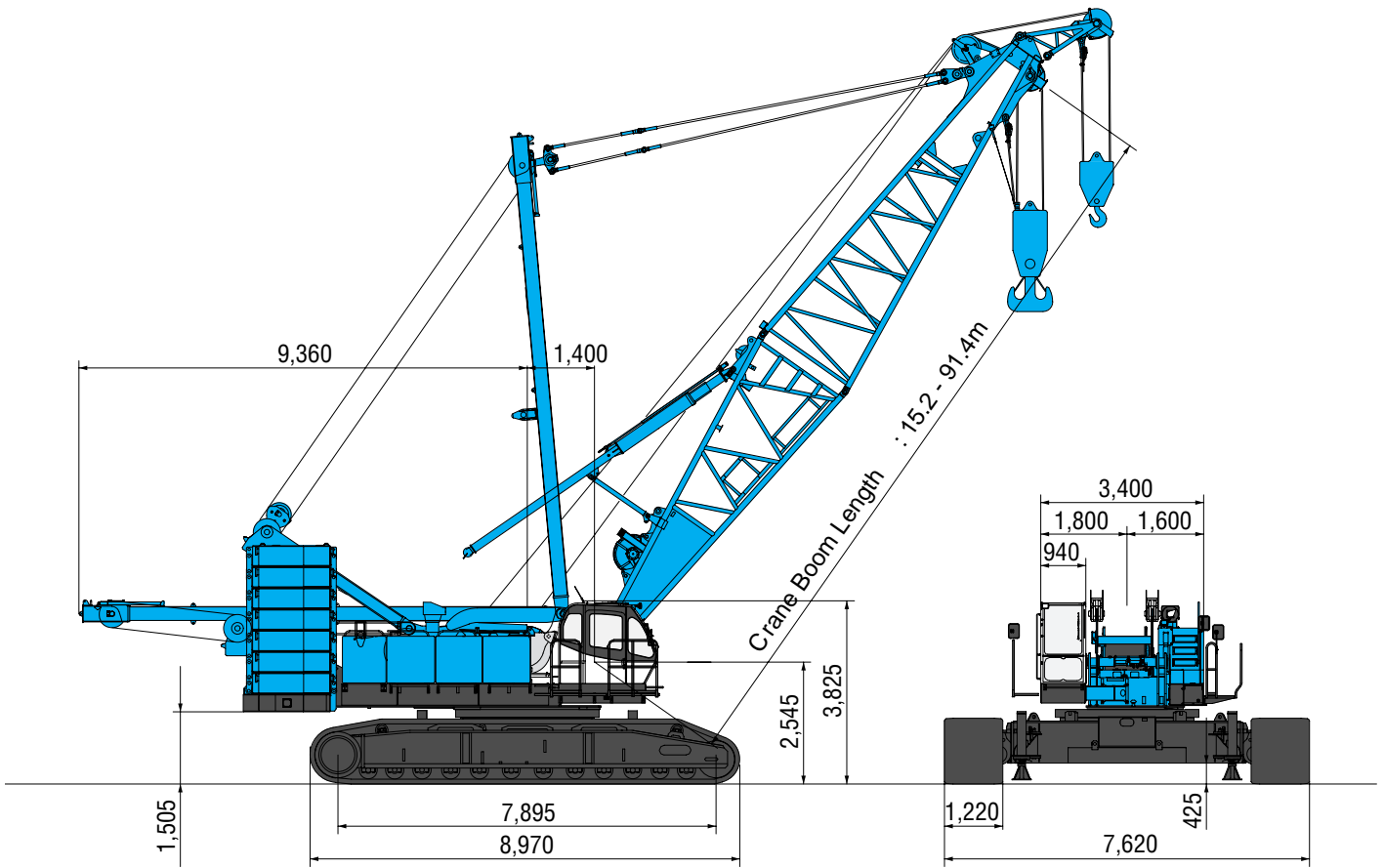

Limit of Hook Lifting

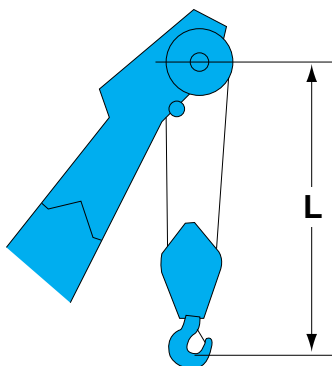

Hook	L
260 t hook	5.3 m
150 t hook	5.9 m
70 t hook	4.9 m
35 t hook	4.7 m

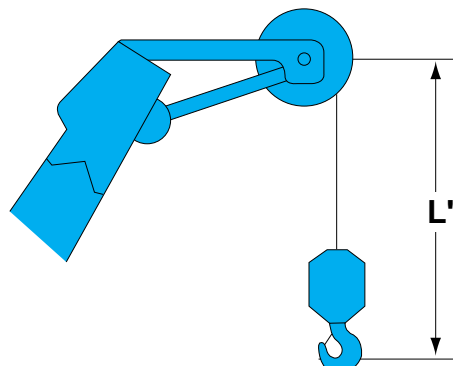

Hook	L'
35 t hook	3.8 m
13.5 t ball hook	3.5 m

Luffing Jib

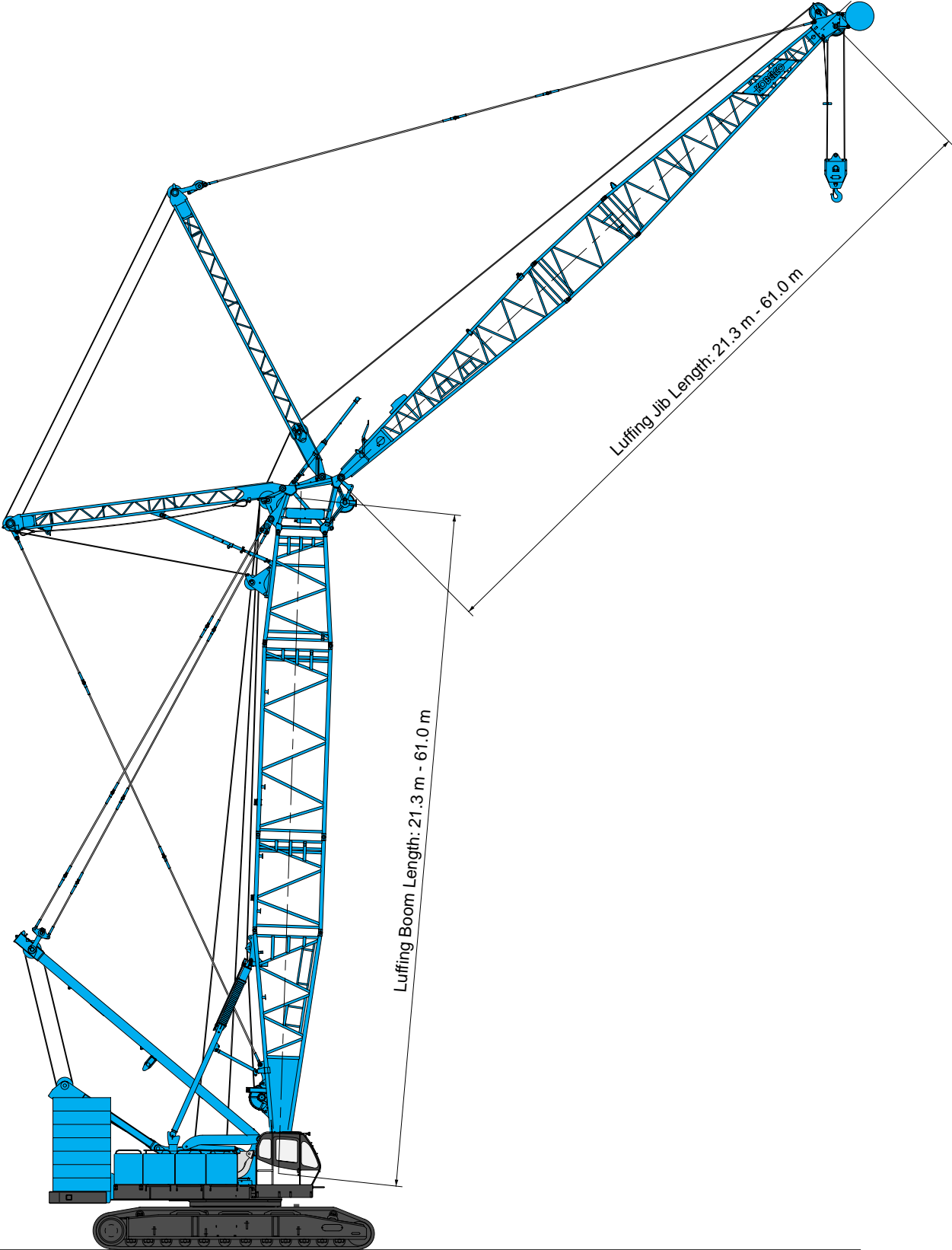

BOOM AND JIB ARRANGEMENTS

Crane Boom Arrangements

Boom length m (ft)	Boom arrangement
15.2 (50)	
18.3 (60)	
21.3 (70)	※
24.4 (80)	※
27.4 (90)	※
30.5 (100)	※
33.5 (110)	※
36.6 (120)	※
39.6 (130)	※
42.7 (140)	※
45.7 (150)	※
48.8 (160)	※
51.8 (170)	※

Boom length m (ft)	Boom arrangement
54.9 (180)	※
57.9 (190)	※
61.0 (200)	※
64.0 (210)	※
67.1 (220)	※
70.1 (230)	※
73.2 (240)	※
76.2 (250)	※
79.3 (260)	※
82.3 (270)	※
85.3 (280)	※
88.4 (290)	※
91.4 (300)	

↗ mark shows the guy line installing position when the fixed jib is used.

※ Indicates the most flexible combination of insert booms, which can be modified to form all shorter boom arrangements.

Symbol	Boom Length	Remarks
	7.6 m	Boom Base
	7.6 m	Boom Top
	3.0 m	Insert Boom
	6.1 m	Insert Boom
	12.2 m	Insert Boom

Fixed Jib Arrangements

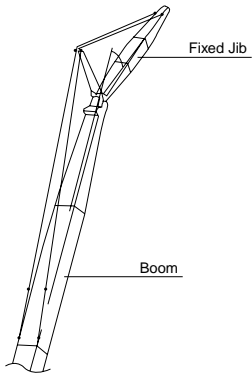

Crane boom length	Jib length m (ft)	Jib arrangement
27.4 m } 76.2 m	12.2 (40)	
	18.3 (60)	
	24.4 (80)	
	30.5 (100)	

Symbol	Jib Length	Remarks
	4.6 m	Jib Base
	4.6 m	Jib Top
	3.0 m	Insert Jib
	6.1 m	Insert Jib

Long Boom Arrangements

Boom length m (ft)	Boom arrangement
64.0 (210)	
67.1 (220)	
70.1 (230)	
73.2 (240)	<p>※</p>
76.2 (250)	<p>※</p>
79.3 (260)	<p>※</p>
82.3 (270)	<p>※</p>
85.3 (280)	<p>※</p>
88.4 (290)	<p>※</p>
91.4 (300)	<p>※</p>

※ Indicates the most flexible combination of insert long booms, which can be modified to form all shorter long boom arrangements.

Symbol	Long Boom Length	Remarks
	7.6 m	Boom Base
	9.1 m	Luffing Jib Top
	3.0 m	Insert Boom
	6.1 m	Insert Boom
	12.2 m	Insert Boom
	4.6 m	Tapered Boom
	3.0 m	Relay Jib
	3.0 m	Luffing Insert Jib
	6.1 m	Luffing Insert Jib
	12.2 m	Luffing Insert Jib

Luffing Boom Arrangements for Luffing

Boom length m (ft)	Boom arrangement
21.3 (70)	※
24.4 (80)	※
27.4 (90)	※
30.5 (100)	※
33.5 (110)	※
36.6 (120)	※
39.6 (130)	※
42.7 (140)	※
45.7 (150)	※

Boom length m (ft)	Boom arrangement
48.8 (160)	※
51.8 (170)	※
54.9 (180)	※
57.9 (190)	※
61.0 (200)	※

※ Indicates the most flexible combination of insert luffing booms, which can be modified to form all shorter luffing boom arrangements.

Symbol	Luffing Boom Length	Remarks
	7.6 m	Boom Base
	1.0 m	Luffing Boom Top
	3.6 m	Luffing Tapered Boom
	3.0 m	Insert Boom
	6.1 m	Insert Boom
	12.2 m	Insert Boom

Luffing Boom Arrangements for Crane

Boom length m (ft)	Boom arrangement
15.2 (50)	
18.3 (60)	※
21.3 (70)	※
24.4 (80)	※
27.4 (90)	※
30.5 (100)	※
33.5 (110)	※
36.6 (120)	※
39.6 (130)	※
42.7 (140)	※

Boom length m (ft)	Boom arrangement
45.7 (150)	※
48.8 (160)	※
51.8 (170)	※
54.9 (180)	※
57.9 (190)	※
61.0 (200)	※

※ Indicates the most flexible combination of insert luffing booms, which can be modified to form all shorter luffing boom arrangements.

Symbol	Luffing Boom Length	Remarks
	7.6 m	Boom Base
	1.0 m	Luffing Boom Top
	3.6 m	Luffing Tapered Boom
	3.0 m	Insert Boom
	6.1 m	Insert Boom
	12.2 m	Insert Boom

Luffing Jib Arrangements

Jib length m (ft)	Jib arrangement
21.3 (70)	※
24.4 (80)	※
27.4 (90)	※
30.5 (100)	※
33.5 (110)	※
36.6 (120)	※

Jib length m (ft)	Jib arrangement
39.6 (130)	※
42.7 (140)	※
45.7 (150)	※
48.8 (160)	※

↖ mark shows the installing position for mid suspension guy line.

※ Indicates the most flexible combination of insert luffing jibs, which can be modified to form all shorter luffing jib arrangements.

Jib length m (ft)	Jib arrangement
51.8 (170)	※
54.9 (180)	※
57.9 (190)	※
61.0 (200)	※

Symbol	Luffing Jib Length	Remarks
	9.1 m	Luffing Jib Base
	9.1 m	Luffing Jib Top
	3.0 m	Relay Jib
	3.0 m	Luffing Insert Jib
	6.1 m	Luffing Insert Jib
	12.2 m	Luffing Insert Jib

Luffing Boom and Jib Combinations.

		Jib Length (m)														
		21.3	24.4	27.4	30.5	33.5	36.6	39.6	42.7	45.7	48.8	51.8	54.9	57.9	61.0	
Boom Length (m)	21.3	○	○	○	○	○	○	○	○	○	○	○	○	○	○	○
	24.4	○	○	○	○	○	○	○	○	○	○	○	○	○	○	○
	27.4	○	○	○	○	○	○	○	○	○	○	○	○	○	○	○
	30.5	○	○	○	○	○	○	○	○	○	○	○	○	○	○	○
	33.5	○	○	○	○	○	○	○	○	○	○	○	○	○	○	○
	36.6	○	○	○	○	○	○	○	○	○	○	○	○	○	○	○
	39.6	○	○	○	○	○	○	○	○	○	○	○	○	○	○	○
	42.7	○	○	○	○	○	○	○	○	○	○	○	○	○	○	○
	45.7	○	○	○	○	○	○	○	○	○	○	○	○	○	○	○
	48.8	○	○	○	○	○	○	○	○	○	○	○	○	○	○	○
	51.8	○	○	○	○	○	○	○	○	○	○	○	○	○	○	○
	54.9	○	○	○	○	○	○	○	○	○	○	○	○	○	○	○
57.9	○	○	○	○	○	○	○	○	○	○	○	○	○	○	○	
61.0	×	×	×	○	○	○	○	○	○	○	○	○	○	○	○	

○ : Combinations which is allowed. × : Combinations which is not allowed.



Hook Blocks

A range of hook blocks can be specified, each with a safety latch.

Hooks	Weight (kg)	No. of sheaves	No. of lines and max. rated loads (tons)							
			1	2	3	4	5	6	7	8
260-ton	4,160	11	-	-	-	54.0	-	81.0	-	108.0
150-ton	2,300	6	-	-	40.5	54.0	67.5	81.0	94.5	108.0
70-ton	1,200	3	-	27.0	40.5	54.0	67.5	70.0	-	-
35-ton	900	1	-	27.0	35.0	-	-	-	-	-
13.5-ton ball hook	450	0	13.5	-	-	-	-	-	-	-

Hooks	Weight (kg)	No. of sheaves	No. of lines and max. rated loads (tons)							
			9	10	12	14	16	18	20	22
260-ton	4,160	11	-	135.0	160.0	183.0	205.0	227.0	240.0	260.0
150-ton	2,300	6	121.5	135.0	150.0	-	-	-	-	-
70-ton	1,200	3	-	-	-	-	-	-	-	-
35-ton	900	1	-	-	-	-	-	-	-	-
13.5-ton ball hook	450	0	-	-	-	-	-	-	-	-



Main Hoist Drum Rated Loads in Metric Tons

No. of Parts of Line	1	2	3	4	5	6	7	8
Max. Loads (ton)	13.5	27.0	40.5	54.0	67.5	81.0	94.5	108.0
No. of Parts of Line	9	10	12	14	16	18	20	22
Max. Loads (ton)	121.5	135.0	160.0	183.0	205.0	227.0	240.0	260.0

Style and Combination of Boom and Jib

	Style	Crane Boom	Luffing Boom	Long Boom	Fixed Jib	Luffing Jib
Boom	7.6 m boom base	Common use(1)	Common use(1)	Common use(1)	Common use(1)	Common use(1)
	7.6 m boom top	Common use(1)	N.A.	N.A.	Common use(1)	N.A.
	1.0 m luffing boom top	N.A.	Common use(1)	N.A.	N.A.	Common use(1)
	3.0 m insert boom	Common use(1)	Common use(2)	Common use(2)	Common use(2)	Common use(2)
	6.1 m insert boom	Common use(2)	Common use(1)	Common use(1)	Common use(1)	Common use(1)
	12.2 m insert boom	Common use(5)	Common use(3)	Common use(3)	Common use(4)	Common use(3)
	3.6 m luffing tapered boom	N.A.	Common use(1)	N.A.	N.A.	Common use(1)
	4.6 m tapered boom	N.A.	N.A.	Long Boom only(1)	N.A.	N.A.
Jib	4.6 m jib base	-	-	N.A.	Fixed jib only(1)	N.A.
	4.6 m jib top	-	-	N.A.	Fixed jib only(1)	N.A.
	3.0 m insert jib	-	-	N.A.	Fixed jib only(1)	N.A.
	6.1 m insert jib	-	-	N.A.	Fixed jib only(3)	N.A.
	9.1 m luffing jib base	-	-	N.A.	N.A.	Luffing jib only(1)
	9.1 m luffing jib top	-	-	Common use(1)	N.A.	Common use(1)
	3.0 m relay jib	-	-	Common use(1)	N.A.	Common use(1)
	3.0 m luffing insert jib	-	-	Common use(2)	N.A.	Common use(1)
	6.1 m luffing insert jib	-	-	Common use(2)	N.A.	Common use(2)
	12.2 m luffing insert jib	-	-	Common use	N.A.	Common use(2)

Note: 1. Figure in () means the numbers of the maximum usable boom (or jib) respectively.
2. N.A.: Not applicable

Symbols for Attachments:

Crane Boom	Auxiliary Sheave for Crane Boom	Luffing Boom	Auxiliary Sheave for Luffing Boom	Long Boom	Auxiliary Sheave for Long Boom	Fixed Jib	Luffing Jib	Luffing Boom with Luffing Jib

WORKING RANGES AND LIFTING CAPACITIES

Crane Boom Working Ranges

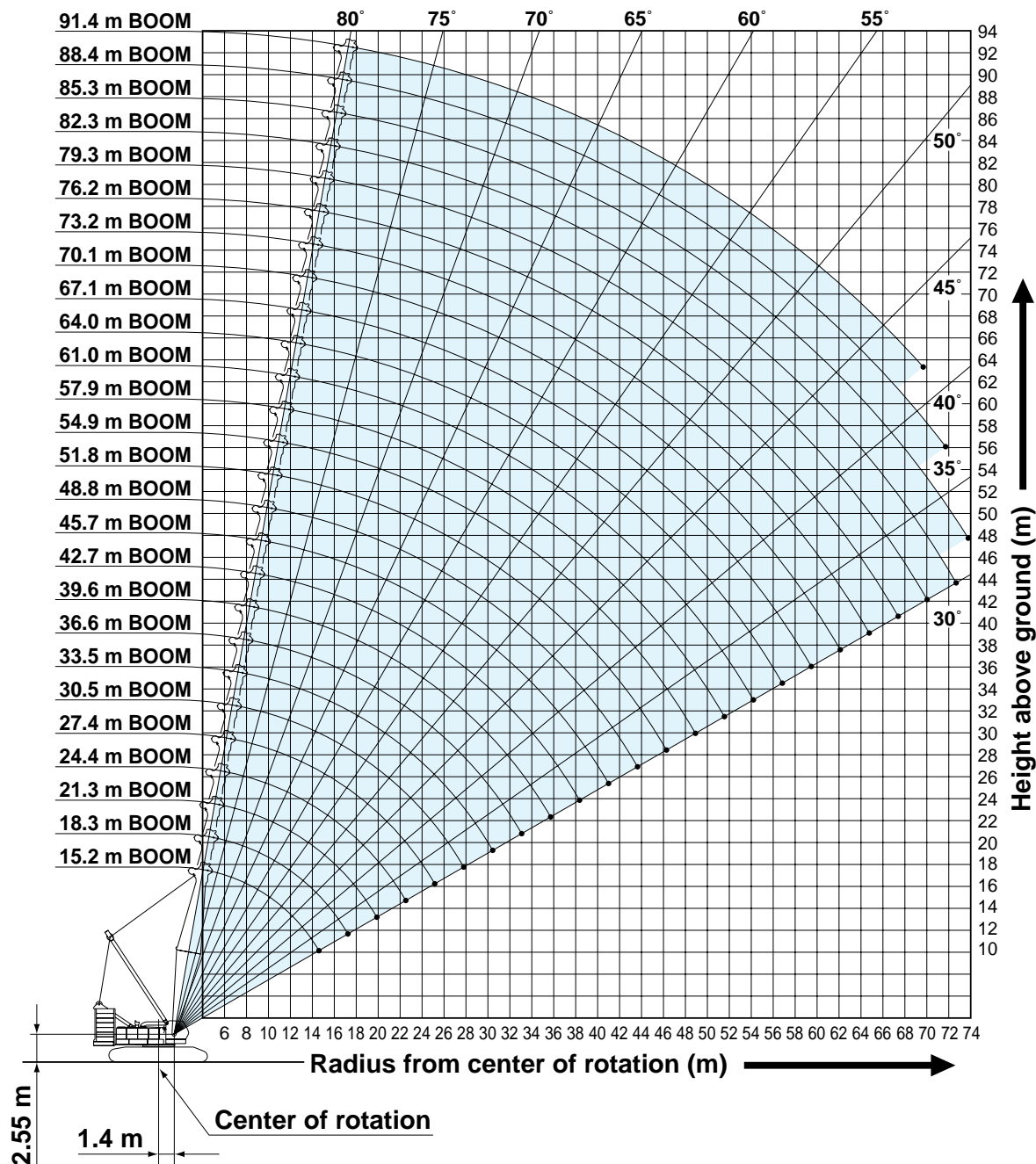

NOTES:

1. Ratings according to EN13000.
2. Ratings in metric tons for 360° working area.
3. Operating radius is the horizontal distance from center of rotation to a vertical line through the center of gravity of the load.
4. Weight of hook block(s), slings and other load handling accessories is included in rated load. Their total weight must be subtracted from rated load to obtain weight that can be lifted.
5. Ratings shown are based on freely suspended loads and make no allowance for such factors as wind effect on lifted load, ground conditions out-of-level, operating speeds or any other condition that could be detrimental to the safe operation of this equipment. Operator, therefore, has the responsibility to judge the existing conditions and reduce lifted loads and operating speeds accordingly.
6. Ratings are for operation on a firm and level surface, up to 1% gradient.
7. At radii and boom lengths where no ratings are shown on chart, operation is not intended nor approved.
8. Boom inserts and guy lines must be arranged as shown in the

"Operator's Manual".

9. Boom hoist reeving is 16 part line.
10. Gantry must be in raised position for all conditions.
11. Boom backstops are required for all boom lengths.
12. The boom should be erected over the front of crawlers, not laterally.
13. Ratings shown in are determined by the strength of the boom or other structural component.
14. When erecting or lowering the boom length of 88.4 m or over, the pillow plate for erection must be placed at the end of crawlers.
15. Instruction in the "Operator's Manual" must be strictly observed when operating the machine.
16. Crane boom ratings: Deduct weight of hook block, slings, and all other load handling accessories from crane boom ratings shown.
17. Auxiliary sheave ratings for crane boom: Deduct weight of hook block, slings, and all other load handling accessories from auxiliary sheave ratings for crane boom shown.
18. Crane boom lengths for auxiliary sheave mounting are 15.2 m to 88.4 m.



Crane Boom Lifting Capacity

Unit: metric ton

Counterweight: 90.0 t, Carbody weight: 24.0 t

Working radius (m) \ Boom Length (m)	15.2	18.3	21.3	24.4	27.4	30.5	33.5	36.6	39.6	42.7	45.7	48.8	51.8	Boom Length (m) \ Working radius (m)
4.6	4.6 m/260.0													4.6
5.0	230.7	226.7	5.5m/205.0											5.0
6.0	191.5	191.5	191.1	6.1 m/183.0	6.6 m/174.5									6.0
7.0	165.9	165.6	165.2	165.0	164.7	7.1 m/154.2	7.7 m/143.8							7.0
8.0	146.1	145.8	145.4	145.2	144.9	144.6	141.4	8.2 m/127.3	8.7 m/115.7					8.0
9.0	130.4	130.1	129.8	129.6	129.2	127.0	127.3	123.8	114.8	9.2 m/107.2	9.8 m/98.3			9.0
10.0	117.7	117.4	117.1	116.9	114.7	115.0	113.3	110.5	107.4	103.8	97.0	10.3 m/92.6	10.8 m/84.7	10.0
12.0	90.0	90.2	90.2	90.2	90.2	90.1	90.0	89.9	87.8	85.9	83.8	82.0	79.5	12.0
14.0	72.2	72.4	72.4	72.4	72.3	72.2	72.1	72.0	72.0	72.0	70.8	69.4	68.0	14.0
16.0	4.8 m/65.7	60.2	60.2	60.2	60.0	59.9	59.8	59.8	59.7	59.6	59.4	59.3	58.7	16.0
18.0		17.5 m/53.5	51.3	51.3	51.1	51.1	50.9	50.8	50.7	50.7	50.4	50.3	50.2	18.0
20.0			44.6	44.6	44.4	44.3	44.1	44.0	43.9	43.9	43.6	43.5	43.4	20.0
22.0			20.1m/44.3	39.3	39.1	39.0	38.7	38.7	38.6	38.5	38.3	38.2	38.0	22.0
24.0				22.7 m/37.6	34.8	34.7	34.5	34.4	34.3	34.2	34.0	33.8	33.7	24.0
26.0					25.4 m/32.3	31.3	30.9	30.8	30.7	30.7	30.4	30.3	30.1	26.0
28.0						28.3	28.0	27.9	27.8	27.7	27.4	27.3	27.1	28.0
30.0							25.5	25.4	25.2	25.2	24.9	24.8	24.6	30.0
32.0							30.7 m/24.8	23.4	23.1	23.0	22.7	22.6	22.4	32.0
34.0								33.3 m/22.1	21.2	21.1	20.8	20.7	20.5	34.0
36.0									35.9 m/19.7	19.5	19.2	19.1	18.9	36.0
38.0										18.0	17.7	17.6	17.4	38.0
40.0										38.6 m/17.6	16.4	16.3	16.1	40.0
42.0											41.2 m/15.7	15.2	14.9	42.0
44.0												43.9 m/14.2	13.9	44.0
46.0													13.0	46.0
48.0													46.5 m/12.8	48.0
Reeves	22	18	16	14	14	12	12	10	10	8	8	7	7	Reeves

Working radius (m) \ Boom Length (m)	54.9	57.9	61.0	64.0	67.1	70.1	73.2	76.2	79.3	82.3	85.3	88.4	91.4	Boom Length (m) \ Working radius (m)
10.0	11.4 m/81.4	11.9 m/76.1												10.0
12.0	78.0	75.5	12.4 m/68.8	12.9 m/67.5	13.5 m/63.8									12.0
14.0	66.5	65.2	63.3	62.5	61.3	59.4	14.5 m/54.5	15.1 m/49.1	15.6 m/44.7					14.0
16.0	57.5	56.4	55.4	54.2	53.2	51.2	48.4	44.5	41.1	16.1 m/40.9	16.6 m/37.4	17.2 m/33.8	17.7 m/31.0	16.0
18.0	50.0	49.5	48.6	47.6	46.8	45.6	44.9	44.2	43.2	39.7	36.6	33.3	30.9	18.0
20.0	43.2	43.0	42.9	42.2	41.5	40.6	39.9	39.2	38.4	37.6	35.4	32.2	29.8	20.0
22.0	37.8	37.7	37.5	37.3	37.2	36.5	35.7	35.1	34.4	33.6	32.9	31.2	28.8	22.0
24.0	33.5	33.3	33.2	32.9	32.9	32.6	32.2	31.6	30.9	30.2	29.6	29.2	27.7	24.0
26.0	29.9	29.7	29.6	29.4	29.3	29.0	28.9	28.6	28.0	27.3	26.8	26.3	25.7	26.0
28.0	26.9	26.8	26.6	26.4	26.3	26.0	25.9	25.8	25.4	24.8	24.3	23.9	23.3	28.0
30.0	24.4	24.2	24.1	23.8	23.7	23.5	23.3	23.2	23.0	22.6	22.1	21.7	21.2	30.0
32.0	22.2	22.0	21.9	21.6	21.5	21.3	21.1	21.0	20.8	20.5	20.2	19.8	19.3	32.0
34.0	20.3	20.1	20.0	19.7	19.6	19.4	19.2	19.1	18.9	18.6	18.4	18.1	17.6	34.0
36.0	18.6	18.5	18.3	18.1	17.9	17.7	17.5	17.4	17.2	16.9	16.8	16.6	16.1	36.0
38.0	17.2	17.0	16.9	16.6	16.5	16.2	16.0	15.9	15.7	15.4	15.3	15.2	14.7	38.0
40.0	15.9	15.7	15.5	15.3	15.2	14.9	14.7	14.6	14.4	14.1	13.9	13.8	13.5	40.0
42.0	14.7	14.5	14.4	14.1	14.0	13.7	13.5	13.4	13.2	12.9	12.8	12.7	12.4	42.0
44.0	13.7	13.5	13.3	13.0	12.9	12.6	12.5	12.3	12.1	11.8	11.7	11.6	11.3	44.0
46.0	12.7	12.5	12.4	12.1	12.0	11.7	11.5	11.4	11.2	10.9	10.7	10.6	10.4	46.0
48.0	11.9	11.6	11.5	11.2	11.1	10.8	10.7	10.5	10.3	10.0	9.8	9.7	9.4	48.0
50.0	49.1 m/11.4	10.9	10.7	10.4	10.3	10.0	9.9	9.7	9.5	9.1	8.9	8.8	8.5	50.0
52.0		51.8 m/10.2	10.0	9.7	9.6	9.3	9.1	8.9	8.7	8.3	8.1	8.0	7.7	52.0
54.0			9.3	9.1	8.9	8.6	8.4	8.2	7.9	7.6	7.4	7.2	7.0	54.0
56.0			54.4 m/9.2	8.4	8.3	7.9	7.7	7.5	7.2	6.9	6.7	6.5	6.3	56.0
58.0				57.1 m/8.1	7.7	7.3	7.1	6.9	6.6	6.3	6.1	5.9	5.6	58.0
60.0					59.7 m/7.2	6.7	6.5	6.3	6.0	5.7	5.5	5.3	5.0	60.0
62.0						6.2	6.0	5.8	5.5	5.1	4.9	4.8	4.5	62.0
64.0						62.3 m/6.1	5.5	5.3	5.0	4.6	4.4	4.3	4.0	64.0
66.0							65.0 m/5.3	4.8	4.5	4.2	4.0	3.8	3.5	66.0
68.0								67.6 m/4.5	4.1	3.7	3.5	3.3	2.9	68.0
70.0									3.7	3.3	3.1	2.9	2.4	70.0
72.0									70.2 m/3.6	2.9	2.7	2.5		72.0
74.0										72.9 m/2.8	2.4			74.0
Reeves	7	6	6	5	5	5	5	4	4	4	3	3	3	Reeves

Note: Ratings according to EN13000.

Ratings shown in are determined by the strength of the boom or other structural components.

Refer to notes P12.



Auxiliary Sheave Lifting Capacity for Crane Boom (With 70 t Main Hook)

Unit: metric ton

Counterweight: 90.0 t, Carbody weight: 24.0 t

Working radius (m)	Boom Length (m)													Working radius (m)	
	15.2	18.3	21.3	24.4	27.4	30.5	33.5	36.6	39.6	42.7	45.7	48.8	51.8		
5.0	5.4 m/27.0	5.8 m/27.0													5.0
6.0	27.0	27.0	6.3 m/27.0	6.9 m/27.0											6.0
7.0	27.0	27.0	27.0	27.0	7.4 m/27.0	7.9 m/27.0									7.0
8.0	27.0	27.0	27.0	27.0	27.0	27.0	8.5 m/27.0								8.0
9.0	27.0	27.0	27.0	27.0	27.0	27.0	27.0	27.0	9.5 m/27.0						9.0
10.0	27.0	27.0	27.0	27.0	27.0	27.0	27.0	27.0	27.0	27.0	10.6 m/27.0	11.1 m/27.0	11.6 m/27.0		10.0
12.0	27.0	27.0	27.0	27.0	27.0	27.0	27.0	27.0	27.0	27.0	27.0	27.0	27.0	27.0	12.0
14.0	27.0	27.0	27.0	27.0	27.0	27.0	27.0	27.0	27.0	27.0	27.0	27.0	27.0	27.0	14.0
16.0	27.0	27.0	27.0	27.0	27.0	27.0	27.0	27.0	27.0	27.0	27.0	27.0	27.0	27.0	16.0
18.0	16.5 m/27.0	19.2 m/27.0	27.0	27.0	27.0	27.0	27.0	27.0	27.0	27.0	27.0	27.0	27.0	27.0	18.0
20.0			27.0	27.0	27.0	27.0	27.0	27.0	27.0	27.0	27.0	27.0	27.0	27.0	20.0
22.0			21.8 m/27.0	27.0	27.0	27.0	27.0	27.0	27.0	27.0	27.0	27.0	27.0	27.0	22.0
24.0				27.0	27.0	27.0	27.0	27.0	27.0	27.0	27.0	27.0	27.0	27.0	24.0
26.0				24.4 m/27.0	27.0	27.0	27.0	27.0	27.0	27.0	27.0	27.0	27.0	27.0	26.0
28.0					27.1 m/26.6	26.4	26.5	26.4	26.3	26.2	25.9	25.8	25.6		28.0
30.0						29.7 m/23.5	24.0	23.9	23.7	23.7	23.4	23.3	23.1		30.0
32.0							32.4 m/21.0	21.9	21.6	21.5	21.2	21.1	20.9		32.0
34.0								19.9	19.7	19.6	19.3	19.2	19.0		34.0
36.0								35.0 m/18.9	17.8	18.0	17.7	17.6	17.4		36.0
38.0									37.6 m/16.3	16.5	16.2	16.1	15.9		38.0
40.0										15.0	14.9	14.8	14.6		40.0
42.0										40.3 m/14.8	13.6	13.7	13.4		42.0
44.0											42.9 m/13.0	12.6	12.4		44.0
46.0												45.6 m/11.7	11.5		46.0
48.0													10.6		48.0
50.0													48.2 m/10.5		50.0
Reeves	2	2	2	2	2	2	2	2	2	2	2	2	2	2	Reeves

Working radius (m)	Boom Length (m)												Working radius (m)	
	54.9	57.9	61.0	64.0	67.1	70.1	73.2	76.2	79.3	82.3	85.3	88.4		
12.0	12.2 m/27.0	12.7 m/27.0	13.2 m/27.0	13.7 m/27.0										12.0
14.0	27.0	27.0	27.0	27.0	14.3 m/27.0	14.8 m/27.0	15.3 m/27.0	15.9 m/27.0						14.0
16.0	27.0	27.0	27.0	27.0	27.0	27.0	27.0	27.0	16.4 m/27.0	16.9 m/27.0	17.4 m/27.0			16.0
18.0	27.0	27.0	27.0	27.0	27.0	27.0	27.0	27.0	27.0	27.0	27.0	27.0		18.0
20.0	27.0	27.0	27.0	27.0	27.0	27.0	27.0	27.0	27.0	27.0	27.0	27.0		20.0
22.0	27.0	27.0	27.0	27.0	27.0	27.0	27.0	27.0	27.0	27.0	27.0	27.0		22.0
24.0	27.0	27.0	27.0	27.0	27.0	27.0	27.0	27.0	27.0	27.0	27.0	27.0		24.0
26.0	27.0	27.0	27.0	27.0	27.0	27.0	27.0	27.0	26.5	25.8	25.3	24.8		26.0
28.0	25.4	25.3	25.1	24.9	24.8	24.5	24.4	24.3	23.9	23.3	22.8	22.4		28.0
30.0	22.9	22.7	22.6	22.3	22.2	22.0	21.8	21.7	21.5	21.1	20.6	20.2		30.0
32.0	20.7	20.5	20.4	20.1	20.0	19.8	19.6	19.5	19.3	19.0	18.7	18.3		32.0
34.0	18.8	18.6	18.5	18.2	18.1	17.9	17.7	17.6	17.4	17.1	16.9	16.6		34.0
36.0	17.1	17.0	16.8	16.6	16.4	16.2	16.0	15.9	15.7	15.4	15.3	15.1		36.0
38.0	15.7	15.5	15.4	15.1	15.0	14.7	14.5	14.4	14.2	13.9	13.8	13.7		38.0
40.0	14.4	14.2	14.0	13.8	13.7	13.4	13.2	13.1	12.9	12.6	12.4	12.3		40.0
42.0	13.2	13.0	12.9	12.6	12.5	12.2	12.0	11.9	11.7	11.4	11.3	11.2		42.0
44.0	12.2	12.0	11.8	11.5	11.4	11.1	11.0	10.8	10.6	10.3	10.2	10.1		44.0
46.0	11.2	11.0	10.9	10.6	10.5	10.2	10.0	9.9	9.7	9.4	9.2	9.1		46.0
48.0	10.4	10.1	10.0	9.7	9.6	9.3	9.2	9.0	8.8	8.5	8.3	8.2		48.0
50.0	9.6	9.4	9.2	8.9	8.8	8.5	8.4	8.2	8.0	7.6	7.4	7.3		50.0
52.0	50.8 m/9.3	8.7	8.5	8.2	8.1	7.8	7.6	7.4	7.2	6.8	6.6	6.5		52.0
54.0		53.5 m/8.2	7.8	7.6	7.4	7.1	6.9	6.7	6.4	6.1	5.9	5.7		54.0
56.0			7.1	6.9	6.8	6.4	6.2	6.0	5.7	5.4	5.2	5.0		56.0
58.0			56.1 m/7.1	6.2	6.2	5.8	5.6	5.4	5.1	4.8	4.6	4.4		58.0
60.0				58.8 m/5.9	5.6	5.2	5.0	4.8	4.5	4.2	4.0	3.8		60.0
62.0					61.4 m/5.2	4.7	4.5	4.3	4.0	3.6	3.4	3.3		62.0
64.0						4.2	4.0	3.8	3.5	3.1	2.9	2.8		64.0
66.0							3.5	3.3	3.0	2.7	2.5			66.0
68.0							66.7 m/3.3	2.8	2.6					68.0
70.0								69.3 m/2.5						70.0
Reeves	2	2	2	2	2	2	2	2	2	2	2	2	2	Reeves

Note: Ratings according to EN13000.

Ratings shown in are determined by the strength of the boom or other structural components.

Refer to notes P12.

Luffing Boom Working Ranges

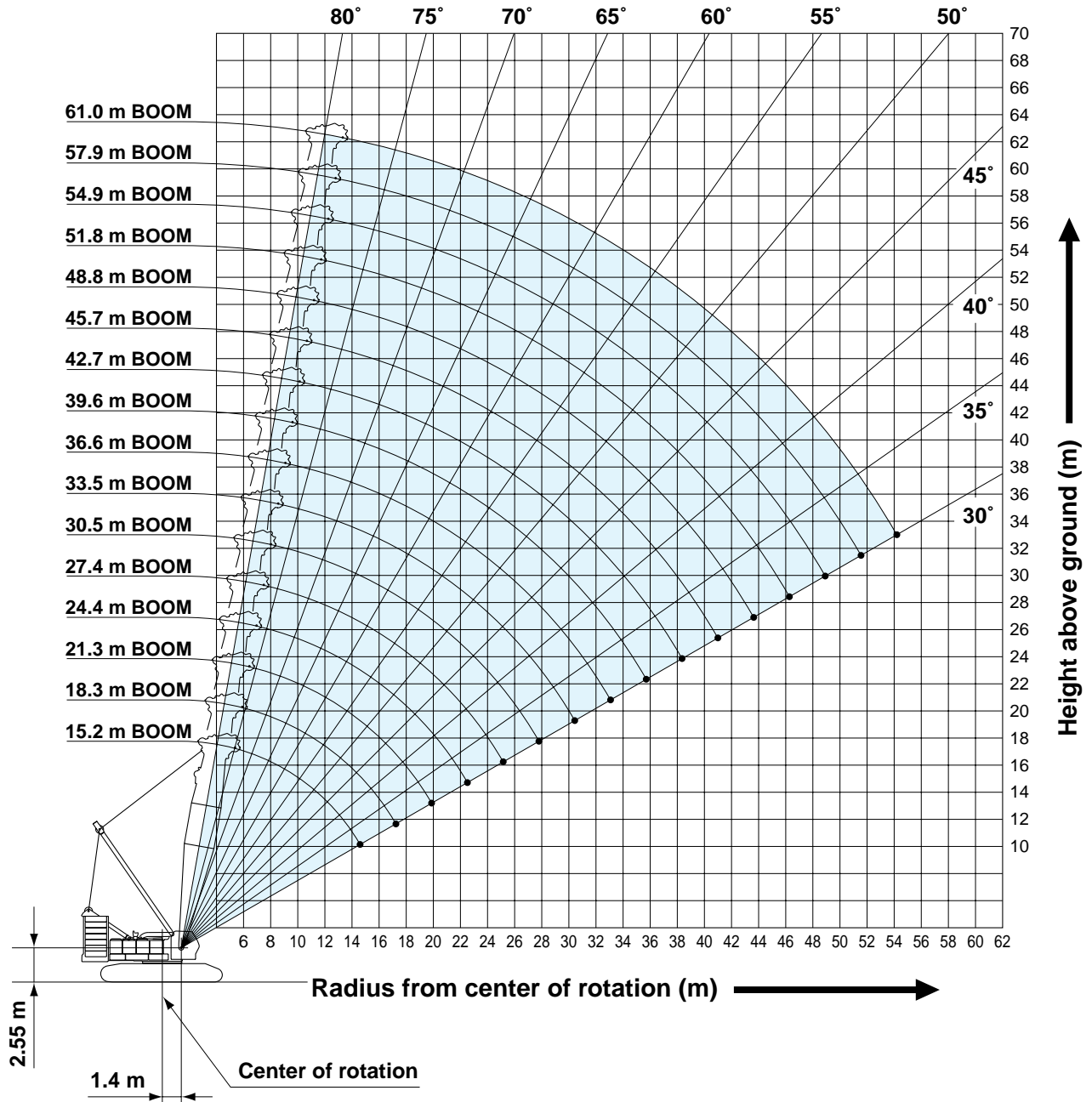

NOTES:

1. Ratings according to EN13000.
2. Ratings in metric tons for 360° working area.
3. Operating radius is the horizontal distance from center of rotation to a vertical line through the center of gravity of the load.
4. Weight of hook block(s), slings and other load handling accessories is included in rated load. Their total weight must be subtracted from rated load to obtain weight that can be lifted.
5. Ratings shown are based on freely suspended loads and make no allowance for such factors as wind effect on lifted load, ground conditions out-of-level, operating speeds or any other condition that could be detrimental to the safe operation of this equipment. Operator, therefore, has the responsibility to judge the existing conditions and reduce lifted loads and operating speeds accordingly.
6. Ratings are for operation on a firm and level surface, up to 1% gradient.
7. At radii and boom lengths where no ratings are shown on chart, operation is not intended nor approved.
8. Boom inserts and guy lines must be arranged as shown in the "Operator's Manual".
9. Boom hoist reeving is 16 part line.
10. Gantry must be in raised position for all conditions.
11. Boom backstops are required for all boom lengths.
12. The boom should be erected over the front of crawlers, not laterally.
13. Ratings shown in are determined by the strength of the boom or other structural component.
14. Instruction in the "Operator's Manual" must be strictly observed when operating the machine.
15. Luffing boom ratings: Deduct weight of hook block, slings, and all other load handling accessories from luffing boom ratings shown.
16. Auxiliary sheave ratings for luffing boom: Deduct weight of hook block, slings, and all other load handling accessories from auxiliary sheave ratings for luffing boom shown.
17. Luffing boom lengths for auxiliary sheave mounting are 15.2 m to 61.0 m.



Luffing Boom Lifting Capacity

Unit: metric ton

Counterweight: 90.0 t, Carbody weight: 24.0 t

Working radius (m)	Boom length (m)												Working radius (m)
	15.2	18.3	21.3	24.4	27.4	30.5	33.5	36.6	39.6	42.7	45.7		
5.0	5.4 m/150.0	5.9 m/143.6											5.0
6.0	150.0	143.6	6.4 m/143.8										6.0
7.0	150.0	143.6	143.8	144.2	7.5 m/144.6								7.0
8.0	144.9	143.6	143.8	144.0	143.8	132.2	8.6 m/116.0						8.0
9.0	129.2	128.9	128.8	128.4	128.2	123.8	114.6	9.1 m/111.3	9.6 m/100.0				9.0
10.0	116.5	116.2	116.0	115.7	114.0	111.8	109.7	107.7	98.5	10.1 m/95.1	10.7 m/83.0		10.0
12.0	88.9	88.8	88.7	88.6	88.5	88.4	88.3	88.2	86.9	84.9	78.8		12.0
14.0	71.2	71.1	71.0	70.9	70.8	70.7	70.6	70.5	70.4	70.3	70.2		14.0
16.0	15.3 m/61.6	59.2	59.1	59.0	58.9	58.8	58.7	58.6	58.5	58.4	58.3		16.0
18.0		17.9 m/50.7	50.5	50.4	50.3	50.2	50.1	50.0	49.9	49.8	49.7		18.0
20.0			43.8	43.7	43.6	43.5	43.4	43.3	43.2	43.0	42.9		20.0
22.0			20.6 m/42.2	38.4	38.3	38.2	38.1	38.0	37.9	37.6	37.5		22.0
24.0				23.2 m/35.7	34.1	33.9	33.8	33.7	33.6	33.3	33.2		24.0
26.0					25.8 m/30.8	30.4	30.3	30.2	30.0	29.8	29.7		26.0
28.0						27.4	27.3	27.2	27.1	26.8	26.7		28.0
30.0						28.5 m/26.8	24.9	24.8	24.6	24.3	24.2		30.0
32.0							31.1 m/23.7	22.6	22.4	22.2	22.1		32.0
34.0								33.8 m/21.0	20.6	20.3	20.2		34.0
36.0									18.9	18.6	18.5		36.0
38.0									36.4 m/18.6	17.2	17.1		38.0
40.0										39.0 m/16.5	15.9		40.0
42.0											41.7 m/15.0		42.0
44.0													44.0
46.0													46.0
Reeves	12	12	12	12	12	10	10	10	8	8	7		Reeves

Working radius (m)	Boom length (m)					Working radius (m)
	48.8	51.8	54.9	57.9	61.0	
10.0	11.2 m/81.0	11.7 m/77.9				10.0
12.0	77.3	76.1	12.3 m/73.2	12.8 m/69.2	13.3 m/65.2	12.0
14.0	68.7	64.9	63.8	63.0	62.0	14.0
16.0	58.2	58.0	56.8	54.8	54.0	16.0
18.0	49.6	49.5	49.3	48.9	47.9	18.0
20.0	42.8	42.7	42.5	42.4	42.2	20.0
22.0	37.4	37.3	37.1	37.0	36.9	22.0
24.0	33.1	33.0	32.8	32.7	32.5	24.0
26.0	29.6	29.5	29.2	29.1	29.0	26.0
28.0	26.6	26.5	26.3	26.2	26.0	28.0
30.0	24.1	24.0	23.7	23.6	23.4	30.0
32.0	21.9	21.8	21.5	21.4	21.3	32.0
34.0	20.0	19.9	19.6	19.5	19.4	34.0
36.0	18.4	18.3	18.0	17.9	17.7	36.0
38.0	16.9	16.8	16.5	16.4	16.2	38.0
40.0	15.6	15.5	15.2	15.1	14.9	40.0
42.0	14.5	14.3	14.1	14.0	13.7	42.0
44.0	13.5	13.3	13.0	12.9	12.7	44.0
46.0	44.3 m/13.3	12.4	12.1	12.0	11.7	46.0
48.0		47.0 m/11.9	11.2	11.1	10.9	48.0
50.0			49.6 m/10.6	10.4	10.1	50.0
52.0				9.7	9.4	52.0
54.0				52.2 m/9.6	8.7	54.0
56.0					54.9 m/8.4	56.0
58.0						58.0
60.0						60.0
62.0						62.0
Reeves	6	6	6	6	5	Reeves

Note: Ratings according to EN13000.

Ratings shown in are determined by the strength of the boom or other structural components.

Refer to notes P15.



Auxiliary Sheave Lifting Capacity for Luffing Boom (With 70 t Main Hook)

Unit: metric ton

Counterweight: 90.0 t, Carbody weight: 24.0 t

Working radius (m)	15.2		18.3		21.3		24.4		27.4		30.5		33.5		36.6		39.6		42.7		45.7		Working radius (m)
	6.0	7.0	8.0	9.0	10.0	12.0	14.0	16.0	18.0	20.0	22.0	24.0	26.0	28.0	30.0	32.0	34.0	36.0	38.0	40.0	42.0	44.0	
6.0	6.2 m/13.5	6.7 m/13.5																					6.0
7.0	13.5	13.5	7.2 m/13.5	7.8 m/13.5																			7.0
8.0	13.5	13.5	13.5	13.5	8.3 m/13.5	8.8 m/13.5																	8.0
9.0	13.5	13.5	13.5	13.5	13.5	13.5	9.4 m/13.5	9.9 m/13.5															9.0
10.0	13.5	13.5	13.5	13.5	13.5	13.5	13.5	13.5	10.4 m/13.5	10.9 m/13.5	11.5 m/13.5												10.0
12.0	13.5	13.5	13.5	13.5	13.5	13.5	13.5	13.5	13.5	13.5	13.5	13.5											12.0
14.0	13.5	13.5	13.5	13.5	13.5	13.5	13.5	13.5	13.5	13.5	13.5	13.5											14.0
16.0	13.5	13.5	13.5	13.5	13.5	13.5	13.5	13.5	13.5	13.5	13.5	13.5											16.0
18.0	16.6 m/13.5	19.2 m/13.5	13.5	13.5	13.5	13.5	13.5	13.5	13.5	13.5	13.5	13.5											18.0
20.0			13.5	13.5	13.5	13.5	13.5	13.5	13.5	13.5	13.5	13.5											20.0
22.0			21.9 m/13.5	13.5	13.5	13.5	13.5	13.5	13.5	13.5	13.5	13.5											22.0
24.0				13.5	13.5	13.5	13.5	13.5	13.5	13.5	13.5	13.5											24.0
26.0				24.5 m/13.5	13.5	13.5	13.5	13.5	13.5	13.5	13.5	13.5											26.0
28.0					27.1 m/13.5	13.5	13.5	13.5	13.5	13.5	13.5	13.5											28.0
30.0						29.8 m/13.5	13.5	13.5	13.5	13.5	13.5	13.5											30.0
32.0							32.4 m/13.5	13.5	13.5	13.5	13.5	13.5											32.0
34.0								13.5	13.5	13.5	13.5	13.5											34.0
36.0								35.1 m/13.5	13.5	13.5	13.5	13.5											36.0
38.0									37.7 m/13.5	13.5	13.5	13.5											38.0
40.0										13.5	13.5	13.5											40.0
42.0											40.3 m/13.5	13.5											42.0
44.0												43.0 m/12.9											44.0
Reeves	1	1	1	1	1	1	1	1	1	1	1	1	1	1	1	1	1	1	1	1	1	1	Reeves

Working radius (m)	48.8		51.8		54.9		57.9		61.0		Working radius (m)
	12.0	14.0	16.0	18.0	20.0	22.0	24.0	26.0	28.0	30.0	
12.0	13.5	12.5 m/13.5	13.1 m/13.5	13.6 m/13.5							12.0
14.0	13.5	13.5	13.5	13.5	14.1 m/13.5						14.0
16.0	13.5	13.5	13.5	13.5	13.5						16.0
18.0	13.5	13.5	13.5	13.5	13.5						18.0
20.0	13.5	13.5	13.5	13.5	13.5						20.0
22.0	13.5	13.5	13.5	13.5	13.5						22.0
24.0	13.5	13.5	13.5	13.5	13.5						24.0
26.0	13.5	13.5	13.5	13.5	13.5						26.0
28.0	13.5	13.5	13.5	13.5	13.5						28.0
30.0	13.5	13.5	13.5	13.5	13.5						30.0
32.0	13.5	13.5	13.5	13.5	13.5						32.0
34.0	13.5	13.5	13.5	13.5	13.5						34.0
36.0	13.5	13.5	13.5	13.5	13.5						36.0
38.0	13.5	13.5	13.5	13.5	13.5						38.0
40.0	13.5	13.5	13.5	13.5	13.5						40.0
42.0	13.3	13.1	12.9	12.8	12.5						42.0
44.0	12.3	12.1	11.8	11.7	11.5						44.0
46.0	45.6 m/11.5	11.2	10.9	10.8	10.5						46.0
48.0		10.3	10.0	9.9	9.7						48.0
50.0		48.3 m/10.2	9.1	9.2	8.9						50.0
52.0			50.9 m/8.7	8.5	8.2						52.0
54.0				53.5 m/8.0	7.5						54.0
56.0					6.8						56.0
58.0					56.2 m/6.7						58.0
60.0											60.0
62.0											62.0
Reeves	1	1	1	1	1	1	1	1	1	1	Reeves

Note: Ratings according to EN13000.

Ratings shown in are determined by the strength of the boom or other structural components.

Refer to notes P15.

Long Boom Working Ranges

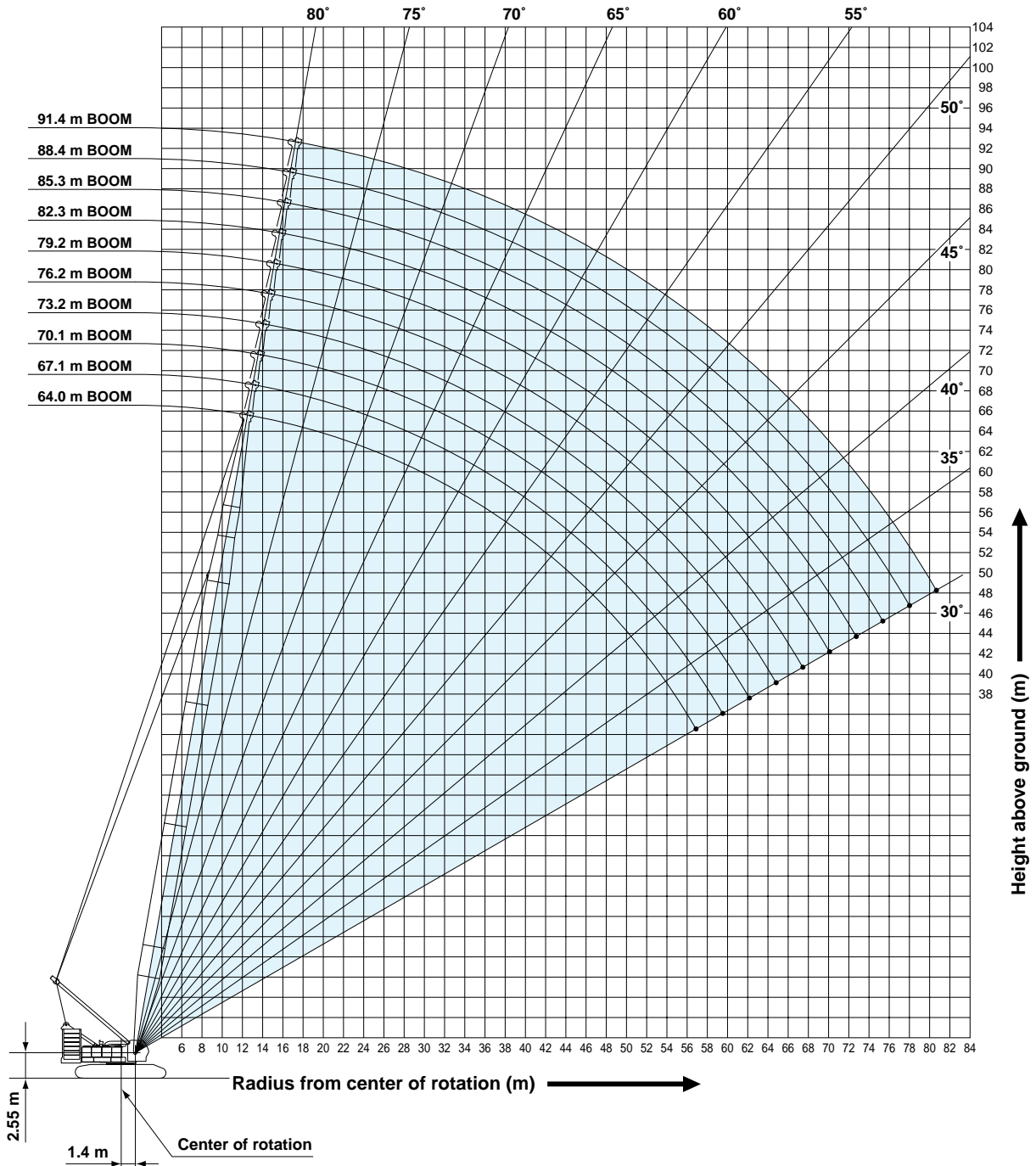

NOTES:

1. Ratings according to EN13000.
2. Ratings in metric tons for 360° working area.
3. Operating radius is the horizontal distance from center of rotation to a vertical line through the center of gravity of the load.
4. Weight of hook block(s), slings and other load handling accessories is included in rated load. Their total weight must be subtracted from rated load to obtain weight that can be lifted.
5. Ratings shown are based on freely suspended loads and make no allowance for such factors as wind effect on lifted load, ground conditions out-of-level, operating speeds or any other condition that could be detrimental to the safe operation of this equipment. Operator, therefore, has the responsibility to judge the existing conditions and reduce lifted loads and operating speeds accordingly.
6. Ratings are for operation on a firm and level surface, up to 1% gradient.
7. At radii and boom lengths where no ratings are shown on chart, operation is not intended nor approved.
8. Boom inserts and guy lines must be arranged as shown in the "Operator's Manual".
9. Boom hoist reeving is 16 part line.
10. Gantry must be in raised position for all conditions.
11. Boom backstops are required for all boom lengths.
12. The boom should be erected over the front of crawlers, not laterally.
13. Ratings shown in are determined by the strength of the boom or other structural component.
14. Instruction in the "Operator's Manual" must be strictly observed when operating the machine.
15. Long boom ratings: Deduct weight of hook block, slings, and all other load handling accessories from long boom ratings shown.
16. Auxiliary sheave ratings for long boom: Deduct weight of hook block, slings, and all other load handling accessories from auxiliary sheave ratings for long boom shown.
17. Long boom lengths for auxiliary sheave mounting are 64.0 m to 91.4 m.



Long Boom Lifting Capacity

Unit: metric ton

**Counterweight: 90.0 t,
Carbody weight: 24.0 t**

Working radius (m)	Boom length (m)		64.0	67.1	70.1	73.2	76.2	79.2	82.3	Boom length (m)	
	Working radius (m)	Working radius (m)									
12.0	12.8 m/47.1	13.3 m/46.1	13.8 m/45.0								12.0
14.0	45.0	44.9	44.8	14.3 m/44.2	14.9 m/41.1	15.4 m/36.2	15.9 m/32.3				14.0
16.0	42.0	41.9	41.8	41.7	39.6	35.5	32.2				16.0
18.0	39.4	39.3	39.2	39.1	37.2	33.2	30.1				18.0
20.0	37.2	37.1	37.0	36.9	35.1	31.3	28.3				20.0
22.0	35.2	35.1	35.0	34.9	33.3	29.6	26.7				22.0
24.0	33.4	33.3	33.2	33.1	31.7	28.0	25.2				24.0
26.0	31.5	31.3	31.2	30.9	30.2	26.7	24.0				26.0
28.0	28.5	28.3	28.1	27.9	27.8	25.5	22.8				28.0
30.0	25.9	25.7	25.6	25.4	25.3	24.4	21.8				30.0
32.0	23.7	23.5	23.4	23.1	23.0	22.9	20.9				32.0
34.0	21.8	21.6	21.5	21.2	21.1	21.0	20.1				34.0
36.0	20.1	19.9	19.8	19.5	19.4	19.3	19.2				36.0
38.0	18.7	18.4	18.3	18.1	18.0	17.9	17.8				38.0
40.0	17.3	17.1	17.0	16.7	16.6	16.5	16.4				40.0
42.0	16.2	15.9	15.8	15.5	15.4	15.3	15.2				42.0
44.0	15.1	14.8	14.7	14.5	14.4	14.3	14.2				44.0
46.0	14.1	13.9	13.7	13.5	13.4	13.3	13.2				46.0
48.0	13.3	13.0	12.9	12.6	12.5	12.4	12.3				48.0
50.0	12.5	12.2	12.1	11.8	11.7	11.6	11.5				50.0
52.0	11.7	11.5	11.3	11.1	11.0	10.9	10.8				52.0
54.0	11.1	10.8	10.7	10.4	10.3	10.2	10.1				54.0
56.0	10.4	10.2	10.0	9.8	9.7	9.6	9.5				56.0
58.0	56.9 m/10.2	9.6	9.5	9.2	9.1	9.0	8.9				58.0
60.0		59.6 m/9.2	8.9	8.7	8.6	8.5	8.4				60.0
62.0			8.5	8.2	8.1	8.0	7.9				62.0
64.0			62.2 m/8.4	7.7	7.6	7.5	7.4				64.0
66.0				64.9 m/7.6	7.2	7.1	7.0				66.0
68.0					67.5 m/6.9	6.8	6.7				68.0
70.0						6.4	6.3				70.0
72.0						70.2 m/6.3	6.0				72.0
74.0							72.8 m/5.9				74.0
Reeves	4	4	4	4	4	3	3				Reeves

Working radius (m)	Boom length (m)		85.3	88.4	91.4	Boom length (m)	
	Working radius (m)	Working radius (m)					
16.0	16.5 m/27.0	17.0 m/24.9	17.5 m/21.3				16.0
18.0	27.0	24.0	20.9				18.0
20.0	25.3	22.4	19.5				20.0
22.0	23.9	21.1	18.3				22.0
24.0	22.6	19.9	17.3				24.0
26.0	21.4	18.9	16.3				26.0
28.0	20.4	18.0	15.5				28.0
30.0	19.5	17.1	14.8				30.0
32.0	18.6	16.4	14.1				32.0
34.0	17.9	15.7	13.6				34.0
36.0	17.2	15.1	13.0				36.0
38.0	16.6	14.6	12.6				38.0
40.0	16.1	14.1	12.1				40.0
42.0	15.1	13.6	11.7				42.0
44.0	14.1	13.2	11.4				44.0
46.0	13.1	12.8	11.0				46.0
48.0	12.2	12.3	10.7				48.0
50.0	11.4	11.3	10.5				50.0
52.0	10.7	10.6	10.2				52.0
54.0	10.0	9.9	9.8				54.0
56.0	9.4	9.3	9.2				56.0
58.0	8.8	8.7	8.6				58.0
60.0	8.3	8.2	8.1				60.0
62.0	7.8	7.7	7.6				62.0
64.0	7.3	7.2	7.1				64.0
66.0	6.9	6.8	6.7				66.0
68.0	6.6	6.5	6.4				68.0
70.0	6.2	6.1	5.9				70.0
72.0	5.9	5.8	5.7				72.0
74.0	5.6	5.5	5.4				74.0
76.0	75.4 m/5.4	5.3	5.1				76.0
78.0		4.9	4.8				78.0
80.0			4.5				80.0
82.0			80.7 m/4.4				82.0
84.0							84.0
Reeves	2	2	2				Reeves

Note:

Ratings according to EN13000.

Ratings shown in are determined by the strength of the boom or other structural components.

Refer to notes P18.



Auxiliary Sheave Lifting Capacity for Long Boom (With 35 t Main Hook)

Unit: metric ton

Counterweight: 90.0 t, Carbody weight: 24.0 t

Working radius (m) \ Boom length (m)	64.0	67.1	70.1	73.2	76.2	79.2	82.3	85.3	88.4	91.4	Working radius (m) \ Boom length (m)
12.0	13.5 m/13.5										12.0
14.0	13.5	13.5	14.5 m/13.5	15.0 m/13.5	15.6 m/13.5						14.0
16.0	13.5	13.5	13.5	13.5	13.5	16.1 m/13.5	16.6 m/13.5	17.2m /13.5	17.7 m/13.5		16.0
18.0	13.5	13.5	13.5	13.5	13.5	13.5	13.5	13.5	13.5	18.2 m/13.5	18.0
20.0	13.5	13.5	13.5	13.5	13.5	13.5	13.5	13.5	13.5	13.5	20.0
22.0	13.5	13.5	13.5	13.5	13.5	13.5	13.5	13.5	13.5	13.5	22.0
24.0	13.5	13.5	13.5	13.5	13.5	13.5	13.5	13.5	13.5	13.5	24.0
26.0	13.5	13.5	13.5	13.5	13.5	13.5	13.5	13.5	13.5	13.5	26.0
28.0	13.5	13.5	13.5	13.5	13.5	13.5	13.5	13.5	13.5	13.5	28.0
30.0	13.5	13.5	13.5	13.5	13.5	13.5	13.5	13.5	13.5	13.5	30.0
32.0	13.5	13.5	13.5	13.5	13.5	13.5	13.5	13.5	13.5	12.8	32.0
34.0	13.5	13.5	13.5	13.5	13.5	13.5	13.5	13.5	13.5	12.3	34.0
36.0	13.5	13.5	13.5	13.5	13.5	13.5	13.5	13.5	13.5	11.7	36.0
38.0	13.5	13.5	13.5	13.5	13.5	13.5	13.5	13.5	13.3	11.3	38.0
40.0	13.5	13.5	13.5	13.5	13.5	13.5	13.5	13.5	12.8	10.8	40.0
42.0	13.5	13.5	13.5	13.5	13.5	13.5	13.5	13.5	12.3	10.4	42.0
44.0	13.5	13.5	13.4	13.2	13.1	13.0	12.9	12.8	11.9	10.1	44.0
46.0	12.8	12.6	12.4	12.2	12.1	12.0	11.9	11.8	11.5	9.7	46.0
48.0	12.0	11.7	11.6	11.3	11.2	11.1	11.0	10.9	11.0	9.4	48.0
50.0	11.2	10.9	10.8	10.5	10.4	10.3	10.2	10.1	10.0	9.2	50.0
52.0	10.4	10.2	10.0	9.8	9.7	9.6	9.5	9.4	9.3	8.9	52.0
54.0	9.8	9.5	9.4	9.1	9.0	8.9	8.8	8.7	8.6	8.5	54.0
56.0	9.1	8.9	8.7	8.5	8.4	8.3	8.2	8.1	8.0	7.9	56.0
58.0	8.4	8.3	8.2	7.9	7.8	7.7	7.6	7.5	7.4	7.3	58.0
60.0		7.7	7.6	7.4	7.3	7.2	7.1	7.0	6.9	6.8	60.0
62.0		60.7 m/7.5	7.2	6.9	6.8	6.7	6.6	6.5	6.4	6.3	62.0
64.0			63.3 m/6.9	6.4	6.3	6.2	6.1	6.0	5.9	5.8	64.0
66.0				5.9	5.9	5.8	5.7	5.6	5.5	5.4	66.0
68.0					5.5	5.5	5.4	5.3	5.2	5.1	68.0
70.0					68.6 m/5.4	5.1	5.0	4.9	4.8	4.6	70.0
72.0						71.3 m/4.8	4.7	4.6	4.5	4.4	72.0
74.0							73.9 m/4.4	4.3	4.2	4.1	74.0
76.0								4.0	4.0	3.8	76.0
78.0								76.5m /3.9	3.8	3.5	78.0
80.0									79.1 m/3.7	3.2	80.0
82.0										81.8 m/2.9	82.0
Reeves	1	1	1	1	1	1	1	1	1	1	Reeves

Note: Ratings according to EN13000.

Ratings shown in are determined by the strength of the boom or other structural components.

Refer to notes P18.

Fixed Jib Working Ranges

Jib Offset Angle: 10°, 30°

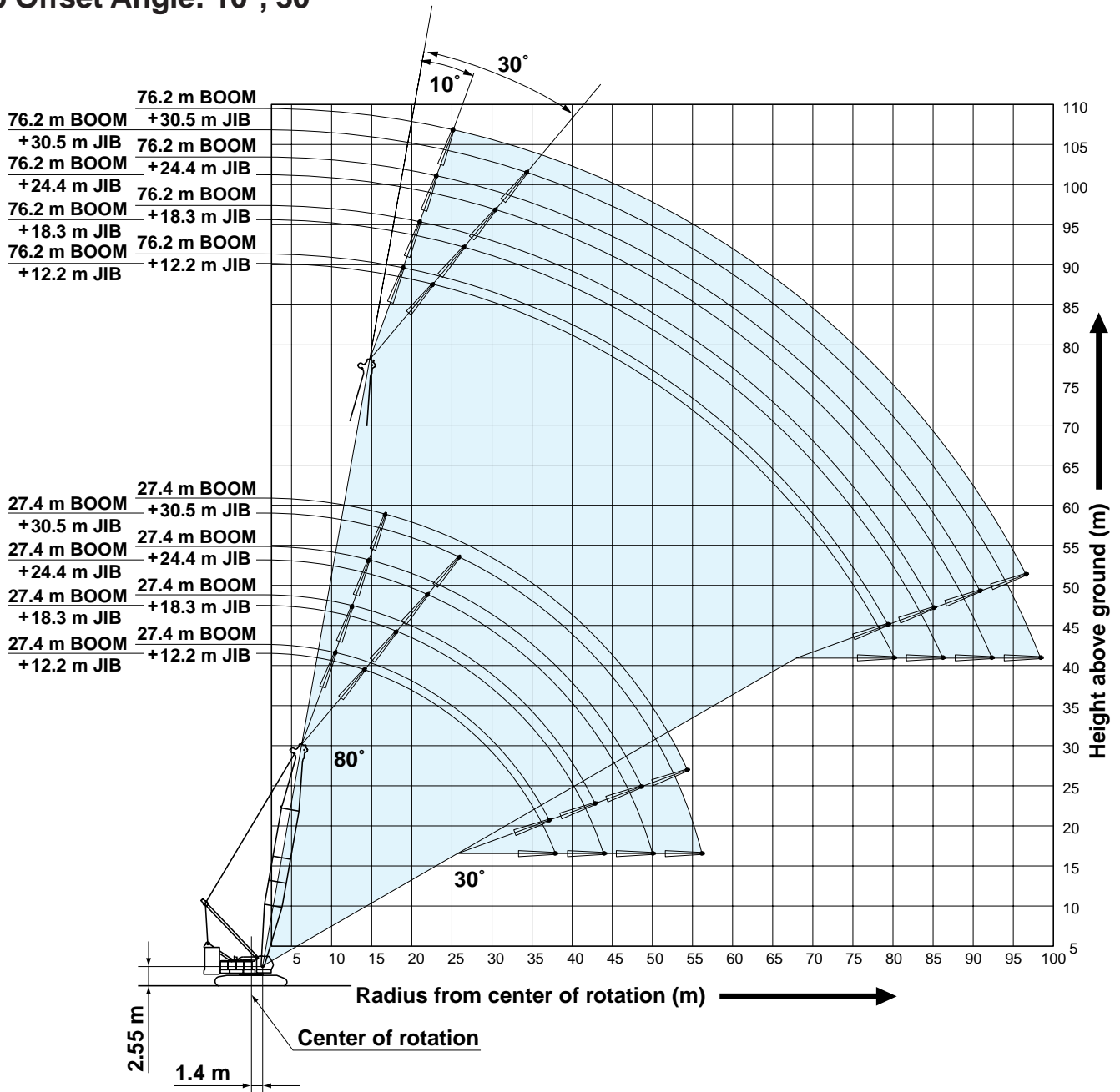

NOTES:

1. Ratings according to EN13000.
2. Ratings in metric tons for 360° working area.
3. Operating radius is the horizontal distance from center of rotation to a vertical line through the center of gravity of the load.
4. Weight of hook block(s), slings and other load handling accessories is included in rated load. Their total weight must be subtracted from rated load to obtain weight that can be lifted.
5. Ratings shown are based on freely suspended loads and make no allowance for such factors as wind effect on lifted load, ground conditions out-of-level, operating speeds or any other condition that could be detrimental to the safe operation of this equipment. Operator, therefore, has the responsibility to judge the existing conditions and reduce lifted loads and operating speeds accordingly.
6. Ratings are for operation on a firm and level surface, up to 1% gradient.
7. At radii and boom lengths where no ratings are shown on chart, operation is not intended nor approved.
8. Boom/ jib inserts and guy lines must be arranged as shown in the "Operator's Manual".
9. Boom hoist reeving is 16 part line.
10. Gantry must be in raised position for all conditions.
11. Boom backstops are required for all boom lengths.
12. The boom should be erected over the front of crawlers, not laterally.
13. Ratings shown in are determined by the strength of the boom or other structural component.
14. When erecting or lowering the boom length of 76.2 m, the pillow plate for erection must be placed at the end of crawlers.
15. Instruction in the "Operator's Manual" must be strictly observed when operating the machine.
16. Fixed jib ratings: Deduct weight of jib hook block, slings, and all other load handling accessories from fixed jib ratings shown.
17. Crane boom lengths for fixed jib mounting are 27.4 m to 76.2 m.
18. One part of line on hook is not allowed to use for 12.2 m jib length with offset angle 10 degrees.



Fixed Jib Lifting Capacities (Without Main Hook)

Unit: metric ton

Jib Offset Angle: 10°

Counterweight: 90.0 t, Carbody weight: 24.0 t

Boom length (m)		27.4				36.6				45.7				54.9				Boom length (m)
Jib length (m)		12.2	18.3	24.4	30.5	12.2	18.3	24.4	30.5	12.2	18.3	24.4	30.5	12.2	18.3	24.4	30.5	Jib length (m)
Working radius (m)	10.0	10.4 m/27.0																10.0
	12.0	25.5	12.5 m/21.2			26.6				13.6 m/26.5								12.0
	14.0	24.3	20.4	14.6 m/12.1		25.5	14.1 m/21.2			26.3	15.7 m/21.2			15.2 m/26.4				14.0
	16.0	23.0	19.3	11.8	16.7 m/6.8	24.5	20.3	16.2 m/12.1		25.4	21.0	17.8 m/12.1		26.2	17.3 m/21.1			16.0
	18.0	21.8	18.4	11.2	6.5	23.6	19.4	11.7	18.3 m/6.8	24.6	20.2	12.1	19.9 m/6.7	25.4	20.9	19.4 m/12.1		18.0
	20.0	20.7	17.5	10.7	6.2	22.7	18.6	11.2	6.5	23.8	19.5	11.6	6.7	24.7	20.2	12.0	21.5 m/6.8	20.0
	22.0	19.8	16.8	10.3	5.9	21.9	17.9	10.8	6.2	23.0	18.8	11.3	6.4	23.9	19.5	11.6	6.7	22.0
	24.0	18.9	16.1	9.9	5.6	21.2	17.2	10.4	5.9	22.2	18.1	10.9	6.2	23.2	18.9	11.3	6.4	24.0
	26.0	18.1	15.4	9.4	5.3	20.5	16.6	10.1	5.7	21.5	17.5	10.5	5.9	22.5	18.3	10.9	6.2	26.0
	28.0	17.3	14.3	9.1	5.1	19.8	16.1	9.7	5.4	20.7	17.0	10.2	5.7	21.9	17.8	10.6	6.0	28.0
	30.0	16.7	13.4	8.7	4.9	19.1	15.5	9.4	5.2	20.0	16.5	9.9	5.5	21.3	17.3	10.3	5.8	30.0
	34.0	15.5	11.9	8.1	4.5	17.8	13.8	8.7	4.8	18.6	15.6	9.3	5.1	20.1	16.4	9.8	5.4	34.0
	38.0	37.1 m/14.5	10.7	7.6	4.2	16.4	12.4	8.2	4.5	17.1	14.0	8.8	4.8	17.4	15.6	9.2	5.1	38.0
	42.0		9.8	7.1	3.9	15.3	11.3	7.7	4.2	15.5	12.8	8.3	4.5	14.9	14.2	8.8	4.8	42.0
	46.0		42.9 m/9.7	6.8	3.7	45.1 m/14.4	10.5	7.3	4.0	13.6	11.8	7.9	4.2	12.8	13.1	8.3	4.5	46.0
	50.0			48.6 m/6.6	3.5		9.8	7.0	3.8	11.9	11.0	7.5	4.0	11.1	11.6	8.0	4.3	50.0
	54.0				3.2		50.8 m/9.6	6.7	3.6	53.0 m/10.9	10.3	7.2	3.8	9.7	10.1	7.6	4.1	54.0
	58.0				54.3 m/3.1			56.5 m/6.5	3.4		9.7	6.9	3.7	8.5	8.9	7.3	3.9	58.0
	62.0								3.2		58.7 m/9.6	6.7	3.5	60.9 m/7.8	7.8	7.1	3.7	62.0
	66.0								62.3 m/3.1			64.4 m/6.5	3.4		6.9	6.8	3.6	66.0
70.0												3.1		66.6 m/6.8	6.5	3.5	70.0	
74.0													70.2 m/3.1		72.4 m/6.1	3.4	74.0	
78.0																3.2	78.0	
82.0																78.1 m/3.2	82.0	
Reeves	2	2	1	1	2	2	1	1	2	2	1	1	2	2	1	1	Reeves	

Boom length (m)		64.0				73.2				76.2				Boom length (m)
Jib length (m)		12.2	18.3	24.4	30.5	12.2	18.3	24.4	30.5	12.2	18.3	24.4	30.5	Jib length (m)
Working radius (m)	16.0	16.8 m/26.5												16.0
	18.0	26.0	18.9 m/21.1			18.4 m/26.4				18.9 m/26.4				18.0
	20.0	25.3	20.7	21.0 m/12.1		25.9	20.5 m/21.1			26.1	21.0 m/21.1			20.0
	22.0	24.7	20.1	11.9	23.0 m/6.7	25.3	20.6	22.5 m/12.1		25.5	20.8	23.1 m/12.0		22.0
	24.0	24.1	19.5	11.6	6.6	24.7	20.0	11.8	24.6 m/6.7	24.9	20.2	11.9	25.2 m/6.7	24.0
	26.0	23.5	19.0	11.3	6.4	24.2	19.5	11.5	6.5	24.4	19.7	11.6	6.6	26.0
	28.0	23.0	18.4	11.0	6.2	23.7	19.0	11.2	6.3	23.9	19.2	11.3	6.4	28.0
	30.0	22.4	18.0	10.7	6.0	22.6	18.5	11.0	6.2	21.7	18.7	11.1	6.2	30.0
	34.0	19.8	17.1	10.2	5.6	18.9	17.7	10.5	5.8	18.3	17.9	10.6	5.9	34.0
	38.0	16.6	16.3	9.7	5.3	15.8	16.3	10.0	5.5	15.5	15.9	10.1	5.6	38.0
	42.0	14.1	14.5	9.2	5.0	13.3	13.8	9.6	5.2	13.0	13.5	9.7	5.3	42.0
	46.0	12.0	12.5	8.8	4.7	11.2	11.7	9.2	4.9	10.9	11.4	9.3	5.0	46.0
	50.0	10.3	10.7	8.4	4.5	9.5	10.0	8.8	4.7	9.2	9.7	8.9	4.8	50.0
	54.0	8.9	9.3	8.0	4.3	8.1	8.5	8.4	4.5	7.8	8.2	8.5	4.5	54.0
	58.0	7.7	8.1	7.7	4.1	6.9	7.3	7.8	4.3	6.5	7.0	7.6	4.4	58.0
	62.0	6.6	7.0	7.5	3.9	5.8	6.2	6.8	4.1	5.5	5.9	6.5	4.2	62.0
	66.0	5.7	6.1	6.6	3.8	4.9	5.3	5.8	4.0	4.6	5.0	5.5	4.0	66.0
	70.0	68.8 m/5.1	5.3	5.7	3.6	4.1	4.5	5.0	3.8	3.7	4.1	4.7	3.9	70.0
	74.0		4.6	5.0	3.5	3.4	3.7	4.3	3.7	3.0	3.4	4.0	3.7	74.0
	78.0		74.6 m/4.5	4.3	3.4	76.7 m/2.9	3.1	3.6	3.6	2.4	2.8	3.3	3.5	78.0
82.0			80.3 m/4.0	3.4		2.5	3.0	3.3	79.4 m/2.2	2.2	2.7	3.0	82.0	
86.0				3.2		82.5 m/2.5	2.5	2.7		85.1 m/1.8	2.2	2.5	86.0	
90.0							88.2 m/2.2	2.1			1.7	2.0	90.0	
94.0								93.9 m/1.8			90.8 m/1.5	1.6	94.0	
98.0											96.6 m/1.3		98.0	
Reeves	2	2	1	1	2	2	1	1	2	2	1	1	Reeves	

Note: Ratings according to EN13000.
 Ratings shown in are determined by the strength of the boom or other structural components.
 Refer to notes P21.
 ※One part of line on hook is not allowed to use for 12.2 m jib length with offset angle 10 degrees.

Jib Offset Angle: 30°

Counterweight: 90.0 t, Carbody weight: 24.0 t

Boom length (m)		27.4				36.6				45.7				54.9				Boom length (m)
Jib length (m)		12.2	18.3	24.4	30.5	12.2	18.3	24.4	30.5	12.2	18.3	24.4	30.5	12.2	18.3	24.4	30.5	Jib length (m)
Working radius (m)	14.0	14.1 m/19.3				15.7 m/19.3												14.0
	16.0	18.7				19.2				17.3 m/19.2								16.0
	18.0	17.9	13.5			18.7	19.6 m/13.5			19.1				18.9 m/19.2				18.0
	20.0	16.8	13.5	21.9 m/8.2		18.1	13.5			18.7	21.2 m/13.5			19.0				20.0
	22.0	15.9	13.1	8.2		17.2	13.5	23.5 m/8.1		18.2	13.5			18.6	22.8 m/13.5			22.0
	24.0	15.2	12.6	7.9	25.9 m/4.4	16.4	13.1	8.1		17.4	13.4	25.1 m/8.1		18.2	13.5			24.0
	26.0	14.5	12.0	7.6	4.4	15.7	12.8	7.9	27.5 m/4.3	16.7	13.2	8.0		17.6	13.4	26.7 m/8.1		26.0
	28.0	13.9	11.4	7.4	4.2	15.1	12.3	7.6	4.3	16.1	12.9	7.8	29.0 m/4.4	17.0	13.2	8.0		28.0
	30.0	13.4	10.9	7.2	4.1	14.6	11.8	7.4	4.2	15.6	12.5	7.6	4.3	16.4	12.9	7.8	30.6 m/4.3	30.0
	34.0	12.7	10.0	6.8	3.8	13.7	10.9	7.1	4.0	14.6	11.6	7.3	4.1	15.5	12.2	7.5	4.2	34.0
	38.0	37.9 m/12.4	9.4	6.5	3.7	13.0	10.2	6.8	3.8	13.9	10.9	7.0	3.9	14.7	11.5	7.2	4.0	38.0
	42.0		9.0	6.2	3.5	12.6	9.6	6.5	3.6	13.3	10.3	6.7	3.7	14.0	10.9	6.9	3.8	42.0
	46.0		44.0 m/8.9	6.1	3.3	45.8 m/12.4	9.2	6.3	3.5	12.8	9.8	6.5	3.6	13.2	10.4	6.7	3.7	46.0
	50.0			6.1	3.3		8.9	6.1	3.4	12.1	9.4	6.3	3.5	11.4	9.9	6.5	3.6	50.0
	54.0			50.1 m/6.1	3.0		51.9 m/8.9	6.1	3.3	53.7 m/10.7	9.1	6.2	3.4	9.9	9.5	6.4	3.5	54.0
	58.0				56.2 m/2.8			6.1	3.1		8.9	6.1	3.3	8.6	9.2	6.2	3.4	58.0
	62.0								2.9		59.8 m/8.9	6.1	3.3	61.6 m/7.6	8.2	6.1	3.3	62.0
	66.0								64.1 m/2.8			65.9 m/6.1	3.1		7.2	6.0	3.2	66.0
	70.0												2.9		67.7 m/6.8	6.0	3.2	70.0
	74.0													72.0 m/2.8		73.8 m/6.0	3.1	74.0
78.0																2.9	78.0	
82.0																79.9 m/2.8	82.0	
Reeves	2	1	1	1	2	1	1	1	2	1	1	1	2	1	1	1	Reeves	

Boom length (m)		64.0				73.2				76.2				Boom length (m)
Jib length (m)		12.2	18.3	24.4	30.5	12.2	18.3	24.4	30.5	12.2	18.3	24.4	30.5	Jib length (m)
Working radius (m)	20.0	20.5 m/19.2												20.0
	22.0	18.9				19.1				22.6 m/19.1				22.0
	24.0	18.6	24.4 m/13.5			18.8				18.9				24.0
	26.0	18.3	13.5			18.6	13.5			18.7	26.5 m/13.5			26.0
	28.0	17.7	13.4	28.3 m/8.1		18.3	13.5	29.9 m/8.1		18.4	13.5			28.0
	30.0	17.2	13.2	7.9	32.2 m/4.3	17.8	13.4	8.0	33.8 m/4.3	18.0	13.4	30.4 m/8.0		30.0
	34.0	16.2	12.8	7.6	4.2	16.8	13.0	7.8	4.3	17.0	13.1	7.8	34.3 m/4.3	34.0
	38.0	15.4	12.0	7.4	4.1	16.0	12.5	7.5	4.1	16.2	12.7	7.5	4.2	38.0
	42.0	14.6	11.4	7.1	3.9	13.9	11.9	7.3	4.0	13.6	12.0	7.3	4.0	42.0
	46.0	12.4	10.9	6.9	3.8	11.7	11.3	7.1	3.8	11.5	11.5	7.1	3.9	46.0
	50.0	10.7	10.4	6.7	3.7	10.0	10.9	6.9	3.7	9.7	10.6	6.9	3.8	50.0
	54.0	9.2	10.0	6.5	3.6	8.5	9.3	6.7	3.6	8.2	9.1	6.7	3.7	54.0
	58.0	7.9	8.7	6.4	3.4	7.2	8.0	6.5	3.5	6.9	7.7	6.6	3.5	58.0
	62.0	6.8	7.5	6.3	3.4	6.1	6.9	6.4	3.4	5.8	6.6	6.4	3.5	62.0
	66.0	5.8	6.5	6.1	3.3	5.1	5.8	6.3	3.4	4.8	5.6	6.1	3.4	66.0
	70.0	69.6 m/5.1	5.6	6.1	3.3	4.2	5.0	5.5	3.3	3.9	4.7	5.2	3.3	70.0
	74.0		4.8	5.3	3.2	3.4	4.2	4.7	3.3	3.2	3.9	4.4	3.3	74.0
	78.0		75.7 m/4.5	4.6	3.2	77.5 m/2.9	3.4	3.9	3.2	2.5	3.2	3.7	3.2	78.0
	82.0			81.8 m/3.9	3.0		2.8	3.3	3.2	80.1 m/2.2	2.5	3.0	3.2	82.0
	86.0				2.9		83.6 m/2.5	2.7	2.9		1.9	2.4	2.8	86.0
90.0				87.8 m/2.8			89.7 m/2.1	2.5		86.2 m/1.9	1.8	2.3	90.0	
94.0								2.0			92.3 m/1.5	1.8	94.0	
98.0								95.8 m/1.7				1.4	98.0	
100.0												98.4 m/1.3	100.0	
Reeves	2	1	1	1	2	1	1	1	2	1	1	1	Reeves	

Note: Ratings according to EN13000. Ratings shown in are determined by the strength of the boom or other structural components. Refer to notes P21.

Luffing Jib Working Ranges

Boom Angle: 88°

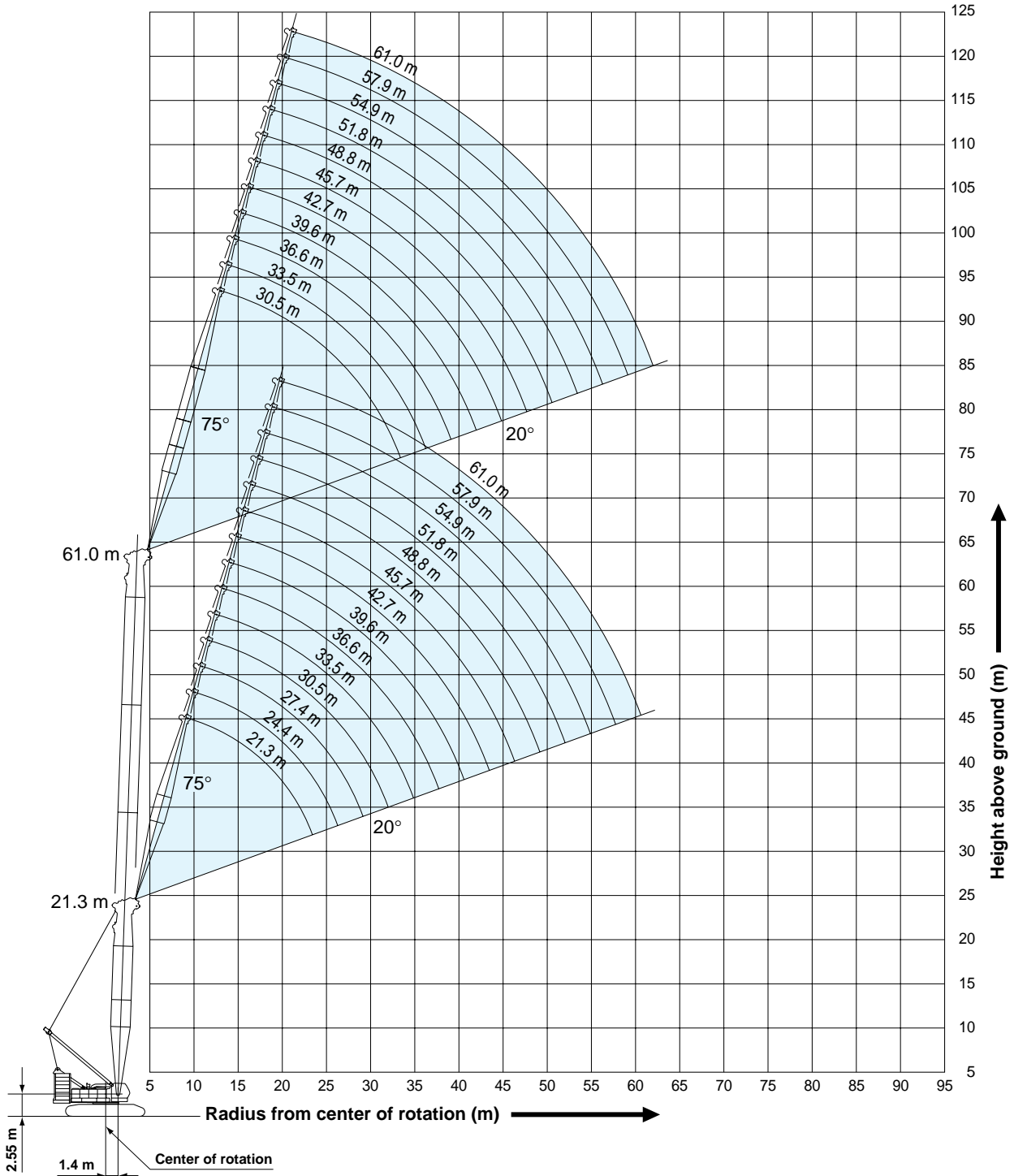

NOTES:

1. Ratings according to EN13000.
2. Ratings in metric tons for 360° working area.
3. Operating radius is the horizontal distance from center of rotation to a vertical line through the center of gravity of the load.
4. Weight of hook block(s), slings and other load handling accessories is included in rated load. Their total weight must be subtracted from rated load to obtain weight that can be lifted.
5. Ratings shown are based on freely suspended loads and make no allowance for such factors as wind effect on lifted load, ground conditions out-of-level, operating speeds or any other condition that could be detrimental to the safe operation of this equipment. Operator, therefore, has the responsibility to judge the existing conditions and reduce lifted loads and operating speeds accordingly.
6. Ratings are for operation on a firm and level surface, up to 1% gradient.
7. At radii and boom lengths where no ratings are shown on chart, operation is not intended nor approved.
8. Boom/jib inserts and guy lines must be arranged as shown in the "Operator's Manual".
9. Luffing boom hoist reeving is 16 part line.
10. Luffing jib hoist reeving is 10 part line.

Boom Angle: 68°

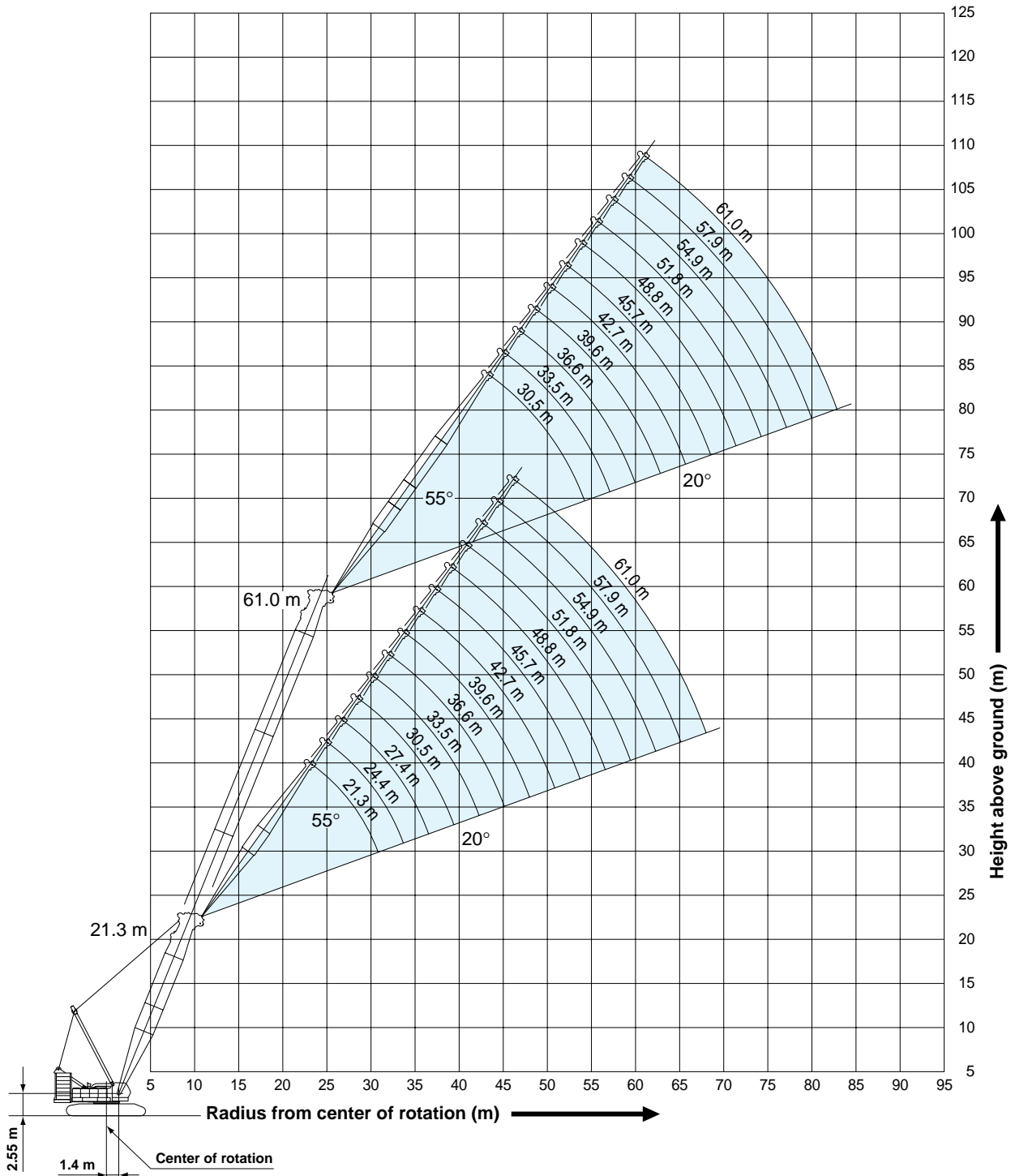

11. Gantry must be in raised position for all conditions.
12. Boom and jib backstops are required for all boom and jib combinations.
13. Ratings shown in are determined by the strength of the boom or other structural component.
14. The boom should be erected over the front of crawlers, not laterally.
15. When erecting or lowering the boom length of 54.9 m or over, the pillow plate for erection must be placed at the end of crawlers.
16. Instruction in the "Operator's Manual" must be strictly observed when operating the machine.

17. All luffing jib ratings and luffing boom ratings with luffing jib shown are calculated in the condition equipped with the auxiliary sheave frame.
18. Luffing jib ratings: Deduct weight of jib hook block, slings, and all other load handling accessories from luffing jib ratings shown.
19. Luffing boom ratings with luffing jib: Deduct weight of main hook block, slings and all other load handling accessories from luffing boom ratings with luffing jib shown.



Luffing Jib Lifting Capacities (Without Main Hook)

Unit: metric ton

Counterweight: 90.0 t, Carbody weight: 24.0 t

21.3 m Boom Length	21.3																	Boom length (m)
	21.3				27.4				33.5				39.6				Jib length (m)	
	88°	83°	68°	63°	88°	83°	68°	63°	88°	83°	68°	63°	88°	83°	68°	63°	Boom angle	
9.8	80.0																9.8	
10.0	79.3																10.0	
12.0	72.2				70.0												12.0	
14.0	65.1	65.7			64.7				54.0								14.0	
16.0	58.0	58.7			58.6	58.6			51.9				39.5				16.0	
18.0	50.9	54.2			52.9	53.5			49.2	52.5			38.7				18.0	
20.0	43.8	47.6			47.2	47.5			46.5	47.3			37.6	38.7			20.0	
22.0	36.7	42.1			41.5	42.0			42.0	41.9			36.3	38.1			22.0	
24.0	27.9	37.8	35.6		36.9	37.7			37.4	37.5			34.8	36.5			24.0	
26.0			32.2		31.7	34.1			33.6	34.0			33.1	33.8			26.0	
28.0			29.4	28.8	26.6	31.1	29.1		30.4	31.0			31.0	30.8			28.0	
30.0			27.0	26.5		27.8	26.7	32.0 m/24.2	27.3	28.4	32.0 m/24.4	36.0 m/20.7	28.2	28.3			30.0	
34.0				32.0 m/24.4			22.8	22.4	20.4	24.3	22.6	19.3	23.8	24.2	36.0 m/21.0		34.0	
38.0								36.0 m/21.3	19.5		36.0 m/21.5	19.7	17.0	18.9	21.1	19.6	40.0 m/17.9	38.0
42.0												17.4	44.0 m/16.0	40.0 m/16.4	17.2	17.2	16.8	42.0
46.0																15.4	15.0	46.0
50.0																48.0 m/14.5	13.4	50.0
Reeves		6				6				4				3				Reeves

27.4 m Boom Length	21.3																	Boom length (m)
	45.7				51.8				57.9				61.0				Jib length (m)	
	88°	83°	68°	63°	88°	83°	68°	63°	88°	83°	68°	63°	88°	83°	68°	63°	Boom angle	
16.0	29.4																16.0	
18.0	28.7				26.6												18.0	
20.0	28.1				26.0				20.9				18.4				20.0	
22.0	27.5	28.1			24.9				20.4				18.3				22.0	
24.0	27.0	27.5			23.8	24.3			19.5				17.6				24.0	
26.0	26.5	27.0			22.7	23.2			18.5	19.2			16.7				26.0	
28.0	25.9	26.6			21.6	22.1			17.5	18.2			15.8	16.4			28.0	
30.0	24.7	25.9			20.4	21.1			16.6	17.2			15.0	15.6			30.0	
34.0	22.4	23.5			18.2	18.9			15.0	15.5			13.6	14.0			34.0	
38.0	20.3	20.9	19.4		16.3	17.0			13.5	14.0			12.3	12.7			38.0	
42.0	16.9	18.4	17.0		14.3	15.0	16.8		12.3	12.7			11.2	11.6			42.0	
46.0	13.3	15.8	15.1	44.0 m/15.6	12.5	13.2	14.9	48.0 m/13.7	11.2	11.6	12.8		10.3	10.6	48.0 m/11.2		46.0	
50.0		48.0 m/14.0	13.6	14.8	10.7	11.5	13.3	12.9	10.2	10.6	11.7	52.0 m/11.6	9.4	9.7	10.7		50.0	
54.0			12.3	13.2	52.0 m/9.7	9.7	11.9	11.7	9.3	9.7	10.8	11.1	8.6	9.0	9.9	10.1	54.0	
58.0				12.0			10.3	10.6	8.2	8.9	9.9	10.2	7.9	8.2	9.1	9.4	58.0	
62.0				56.0 m/11.4			60.0 m/9.5	9.3		60.0 m/8.2	9.1	9.4	7.0	7.5	8.4	8.7	62.0	
66.0											8.0	8.6		64.0 m/7.0	7.8	8.0	66.0	
70.0														68.0 m/7.5	7.4		70.0	
Reeves		3				2				2							Reeves	

27.4 m Boom Length	27.4																	Boom length (m)
	21.3				27.4				33.5				39.6				Jib length (m)	
	88°	83°	68°	63°	88°	83°	68°	63°	88°	83°	68°	63°	88°	83°	68°	63°	Boom angle	
10.0	73.4																10.0	
12.0	67.6				67.5												12.0	
14.0	61.7	65.4			62.4				54.0								14.0	
16.0	55.9	58.4			57.3	58.3			52.1				39.5				16.0	
18.0	50.1	53.9			52.2	53.2			49.4	52.2			38.6				18.0	
20.0	44.2	47.3			47.1	47.2			46.8	47.0			37.5				20.0	
22.0	38.4	41.9			42.0	41.7			42.6	41.6			36.3	38.3			22.0	
24.0	29.7	37.5			37.2	37.4			37.8	37.3			34.8	37.0			24.0	
26.0		33.5	31.4		32.8	33.8			33.9	33.7			33.2	33.6			26.0	
28.0			28.6		27.7	30.8			30.6	30.7			31.3	30.6			28.0	
30.0			26.2	25.5	22.3	28.3	25.9		27.8	28.2			28.5	28.1			30.0	
34.0			32.0 m/24.2	21.8		32.0 m/25.1	22.1	21.5	21.2	24.1	21.9		23.9	24.0			34.0	
38.0							19.2	18.7	36.0 m/17.6	19.7	19.0	18.5	19.5	20.9	18.9		38.0	
42.0								40.0 m/17.6			16.8	16.3	40.0 m/17.1	18.4	16.7	16.1	42.0	
46.0											44.0 m/15.8	14.5		44.0 m/15.9	14.8	14.3	46.0	
50.0															13.3	12.8	50.0	
54.0																52.0 m/12.2	54.0	
Reeves		6				5				4				3			Reeves	

Note: Ratings according to EN13000.

Ratings shown in are determined by the strength of the boom or other structural components. Refer to notes P25 and P26.

Counterweight: 90.0 t, Carbody weight: 24.0 t

27.4 m Boom Length	Boom length (m)	27.4																Boom length (m)
	Jib length (m)	45.7				51.8				57.9				61.0				Jib length (m)
	Boom angle	88°	83°	68°	63°	88°	83°	68°	63°	88°	83°	68°	63°	88°	83°	68°	63°	Boom angle
Working Radius (m)	18.0	28.7			25.7												18.0	
	20.0	28.1			25.4				20.4								20.0	
	22.0	27.5			24.5				20.1				18.1				22.0	
	24.0	27.0	27.7		23.5				19.3				17.4				24.0	
	26.0	26.5	27.2		22.4	22.8			18.4				16.6				26.0	
	28.0	25.9	26.7		21.3	21.7			17.4	18.1			15.7	16.3			28.0	
	30.0	24.7	26.2		20.2	20.7			16.5	17.1			14.9	15.5			30.0	
	34.0	22.4	23.8		18.1	18.7			14.9	15.4			13.5	14.0			34.0	
	38.0	20.4	20.7	40.0 m/17.5	16.2	16.8			13.5	14.0			12.2	12.7			38.0	
	42.0	17.5	18.2	16.4	14.3	14.9	44.0 m/15.2		12.3	12.7			11.2	11.5			42.0	
	46.0	13.8	16.2	14.6	14.1	12.5	13.2	14.3	11.2	11.6	48.0 m/12.2		10.2	10.6			46.0	
	50.0		13.0	13.1	12.6	10.8	11.6	12.8	12.3	10.3	10.6	11.7		9.4	9.7	10.6	50.0	
	54.0			11.8	11.4	52.0 m/10.0	9.9	11.5	11.1	9.4	9.8	10.7	10.8	8.6	8.9	9.8	56.0 m/9.7	54.0
	58.0			56.0 m/11.3	10.3		56.0 m/9.1	10.4	10.0	8.4	9.0	9.9	9.8	8.0	8.3	9.0	9.3	58.0
	62.0							9.0	9.1		7.6	9.1	8.9	7.3	7.6	8.4	8.6	62.0
	66.0								64.0 m/8.7			8.1	8.1		64.0 m/7.3	7.8	8.0	66.0
	70.0											68.0 m/7.5	7.4			7.1	7.3	70.0
	74.0														72.0 m/6.5		6.5	74.0
	Reeves		3				2			2				2				Reeves
33.5 m Boom Length	Boom length (m)	33.5																Boom length (m)
	Jib length (m)	21.3				27.4				33.5				39.6				Jib length (m)
	Boom angle	88°	83°	68°	63°	88°	83°	68°	63°	88°	83°	68°	63°	88°	83°	68°	63°	Boom angle
Working Radius (m)	10.0	67.5																10.0
	12.0	65.3			63.5													12.0
	14.0	60.2			59.3				52.2									14.0
	16.0	55.1	58.1		55.1				50.9				39.5					16.0
	18.0	49.9	53.6		50.9	52.9			48.3				38.7					18.0
	20.0	44.8	47.0		46.7	46.9			45.6	46.5			37.5					20.0
	22.0	39.7	41.7		42.5	41.5			42.7	41.3			36.4	38.5				22.0
	24.0	31.2	37.3		37.6	37.2			38.2	37.0			34.9	36.8				24.0
	26.0		33.7		33.6	33.6			34.2	33.4			33.2	33.3				26.0
	28.0			27.7	28.5	30.7			30.8	30.5			31.5	30.3				28.0
	30.0			25.4	23.3	28.1	32.0 m/23.0		28.0	27.9			28.7	27.8				30.0
	34.0			21.7	21.0		32.0 m/26.0	21.3	21.8	23.9	36.0 m/19.6		24.1	23.8				34.0
	38.0			36.0 m/20.2	18.3			18.5	18.0	36.0 m/18.3	20.8	18.3	20.0	20.7	40.0 m/17.1			38.0
	42.0							40.0 m/17.4	15.9			16.1	15.6	14.9	18.2	16.0	44.0 m/14.4	42.0
	46.0								44.0 m/14.9			14.3	13.8		44.0 m/17.1	14.3	13.6	46.0
	50.0												12.4			12.8	12.2	50.0
	54.0														52.0 m/12.1		11.0	54.0
	58.0																56.0 m/10.5	58.0
	Reeves		5				5			4			3					Reeves
27.4 m Boom Length	Boom length (m)	33.5																Boom length (m)
	Jib length (m)	45.7				51.8				57.9				61.0				Jib length (m)
	Boom angle	88°	83°	68°	63°	88°	83°	68°	63°	88°	83°	68°	63°	88°	83°	68°	63°	Boom angle
Working Radius (m)	18.0	28.8			24.7													18.0
	20.0	28.1			24.4				19.8									20.0
	22.0	27.6			24.1				19.5				17.5					22.0
	24.0	27.0	27.9		23.2				19.2				17.3					24.0
	26.0	26.6	27.3		22.1	22.5			18.3				16.4					26.0
	28.0	25.9	26.8		21.1	21.4			17.3	18.0			15.6					28.0
	30.0	24.7	26.4		20.0	20.4			16.4	17.1			14.8	15.4				30.0
	34.0	22.4	23.6		18.0	18.4			14.8	15.4			13.4	13.9				34.0
	38.0	20.4	20.5		16.1	16.6			13.4	13.9			12.1	12.6				38.0
	42.0	17.8	18.0	44.0 m/14.9	14.3	14.8			12.2	12.6			11.1	11.5				42.0
	46.0	14.2	16.1	14.0	48.0 m/12.6	12.5	13.2	13.7	11.2	11.6			10.2	10.5				46.0
	50.0	48.0 m/12.2	13.9	12.5	12.0	10.9	11.6	12.3	52.0 m/11.0	10.2	10.6	11.6		9.4	9.7	52.0 m/10.1		50.0
	54.0			11.3	10.8	52.0 m/10.1	10.0	11.0	10.5	9.4	9.8	10.7	56.0 m/9.7	8.6	8.9	9.7		54.0
	58.0			10.3	9.8		56.0 m/9.2	10.0	9.4	8.5	9.0	9.7	9.2	8.0	8.2	9.0	9.1	58.0
	62.0				8.9			9.0	8.6		7.8	8.8	8.3	7.3	7.6	8.3	8.2	62.0
	66.0							64.0 m/8.4	7.8			8.0	7.6		64.0 m/7.3	7.7	7.5	66.0
	70.0								68.0 m/7.5				7.0	6.9			7.0	70.0
	74.0														6.0		6.2	74.0
	78.0																76.0 m/5.9	78.0
	Reeves		3				2			2				2				Reeves

Note: Ratings according to EN13000.

Ratings shown in are determined by the strength of the boom or other structural components.

Refer to notes P25 and P26.

Counterweight: 90.0 t, Carbody weight: 24.0 t

39.6 m Boom Length	39.6																	Boom length (m)			
	Jib length (m)																Jib length (m)				
	Boom angle	21.3				27.4				33.5				39.6				Boom angle			
Working Radius (m)	88°	83°	68°	63°	88°	83°	68°	63°	88°	83°	68°	63°	88°	83°	68°	63°	88°	83°	68°	63°	Reeves
10.0	64.5																				10.0
12.0	60.6				54.0																12.0
14.0	56.6				54.0				48.5												14.0
16.0	52.7	57.7			53.0				48.1					37.4							16.0
18.0	48.8	53.2			49.5	52.5			47.1					37.0							18.0
20.0	44.8	46.6			46.1	46.5			44.8	46.1				36.6							20.0
22.0	40.9	41.3			42.7	41.2			42.6	40.9				36.2	37.1						22.0
24.0	32.4	37.0			38.0	36.9			38.2	36.6				35.0	36.5						24.0
26.0		33.4			33.9	33.3			34.5	33.1				33.3	33.0						26.0
28.0		30.4			29.2	30.4			31.1	30.2				31.5	30.0						28.0
30.0			32.0 m/22.5		24.0	27.9			28.2	27.7				28.9	27.5						30.0
34.0			20.9	36.0 m/18.6		23.8	20.4		22.3	23.6				24.2	23.5						34.0
38.0			18.1	17.4			17.7	40.0 m/16.0	36.0 m/18.8	20.6	17.5			20.4	20.5						38.0
42.0				40.0 m/16.3			15.6	15.0				15.4	44.0 m/13.8	15.4	18.0	15.3					42.0
46.0							44.0 m/14.7	13.4				13.7	13.0		44.0 m/17.0	13.6	48.0 m/12.1				46.0
50.0												12.3	11.7			12.2	11.5				50.0
54.0													52.0 m/11.1			11.0	10.3				54.0
58.0																	9.4				58.0
Reeves			5				4				4				3						Reeves

45.7 m Boom Length	39.6																	Boom length (m)			
	Jib length (m)																Jib length (m)				
	Boom angle	45.7				51.8				57.9				61.0				Boom angle			
Working Radius (m)	88°	83°	68°	63°	88°	83°	68°	63°	88°	83°	68°	63°	88°	83°	68°	63°	88°	83°	68°	63°	Reeves
18.0	28.8																				18.0
20.0	28.2				23.4					19.0											20.0
22.0	27.6				23.2					18.7					16.9						22.0
24.0	27.0	28.0			22.9					18.4					16.7						24.0
26.0	26.6	27.5			21.9	22.1				18.1					16.3						26.0
28.0	25.9	27.0			20.8	21.1				17.2					15.5						28.0
30.0	24.7	26.5			19.8	20.1				16.3	17.0				14.7	15.4					30.0
34.0	22.5	23.3			17.8	18.2				14.7	15.3				13.3	13.8					34.0
38.0	20.4	20.3			15.9	16.4				13.3	13.8				12.1	12.5					38.0
42.0	17.9	17.8			14.1	14.6				12.1	12.6				11.0	11.4					42.0
46.0	14.5	15.9	13.3		12.5	13.0	48.0 m/12.3			11.1	11.5				10.1	10.4					46.0
50.0	48.0 m/12.5	14.2	11.9	52.0 m/10.6	10.9	11.5	11.6			10.2	10.5	52.0 m/10.8			9.3	9.6					50.0
54.0			10.7	10.1	9.2	10.0	10.4	56.0 m/9.3		9.4	9.7	10.2			8.6	8.9	9.6				54.0
58.0			9.7	9.1		56.0 m/9.3	9.4	8.8	8.4	8.9	9.2	60.0 m/8.1			7.9	8.2	8.9				58.0
62.0			60.0 m/9.3	8.3			8.6	8.0	60.0 m/7.7	7.7	8.3	7.7	8.3	7.7	6.7	7.6	8.2	7.6			62.0
66.0				64.0 m/7.9			7.8	7.2					7.6	7.0		6.7	7.4	6.8			66.0
70.0								6.6					6.9	6.3			6.8	6.2			70.0
74.0													72.0 m/6.4	5.7			5.9	5.6			74.0
78.0														76.0 m/5.5			76.0 m/5.4	5.1			78.0
Reeves			3				2				2				2						Reeves

45.7 m Boom Length	45.7																	Boom length (m)			
	Jib length (m)																Jib length (m)				
	Boom angle	21.3				27.4				33.5				39.6				Boom angle			
Working Radius (m)	88°	83°	68°	63°	88°	83°	68°	63°	88°	83°	68°	63°	88°	83°	68°	63°	88°	83°	68°	63°	Reeves
12.0	54.0				49.0																12.0
14.0	54.0				47.5					40.5											14.0
16.0	53.0	54.0			46.0					40.5					35.2						16.0
18.0	49.3	52.8			44.6					40.5					34.9						18.0
20.0	45.4	46.2			43.1	45.7				40.5					34.6						20.0
22.0	41.9	40.9			41.6	40.7				38.5	40.3				33.8						22.0
24.0	33.4	36.6			38.2	36.5				36.4	36.4				32.6	35.0					24.0
26.0		33.1			34.2	33.0				34.4	32.9				31.3	32.6					26.0
28.0		30.1			29.8	30.1				31.3	30.0				30.1	29.6					28.0
30.0					24.7	27.6				28.4	27.5				28.8	27.2					30.0
34.0						23.6				22.7	23.5				24.4	23.3					34.0
38.0								16.9		36.0 m/19.3	20.4	40.0 m/15.6			20.7	20.2					38.0
42.0				40.0 m/16.2	14.4			14.9	14.1		40.0 m/19.1	14.6			15.7	17.8	44.0 m/13.7				42.0
46.0				44.0 m/13.6				13.2	12.6			13.0	12.3			15.8	12.9				46.0
50.0									11.2			11.6	11.0				11.5	10.7			50.0
54.0												52.0 m/11.0	9.9				10.4	9.6			54.0
58.0													56.0 m/9.5				9.4	8.7			58.0
62.0																		60.0 m/8.3			62.0
Reeves			4				4				3				3						Reeves

Note: Ratings according to EN13000.

Ratings shown in are determined by the strength of the boom or other structural components. Refer to notes P25 and P26.

Counterweight: 90.0 t, Carbody weight: 24.0 t

45.7 m Boom Length	45.7																	Boom length (m)
	45.7				51.8				57.9				61.0				Jib length (m)	
	Boom angle	88°	83°	68°	63°	88°	83°	68°	63°	88°	83°	68°	63°	88°	83°	68°	63°	Boom angle
Working Radius (m)	18.0	28.1																18.0
	20.0	27.8			22.4				18.3									20.0
	22.0	27.5			22.1				18.0				16.3					22.0
	24.0	27.1			21.8				17.7				16.1					24.0
	26.0	26.6	27.6		21.5				17.4				15.9					26.0
	28.0	26.0	27.1		20.6	20.8			17.1				15.4					28.0
	30.0	24.7	26.6		19.6	19.8			16.2	17.0			14.6	15.3				30.0
	34.0	22.5	23.0		17.6	17.9			14.6	15.3			13.2	13.8				34.0
	38.0	20.4	20.0		15.8	16.1			13.2	13.8			12.0	12.5				38.0
	42.0	18.0	17.6		14.0	14.5			12.1	12.5			10.9	11.4				42.0
	46.0	14.7	15.6	48.0 m/11.9	12.4	12.9			11.0	11.4			10.0	10.4				46.0
	50.0	48.0 m/12.8	14.0	11.3	10.8	11.4	52.0 m/10.4		10.1	10.5			9.2	9.5				50.0
	54.0		52.0 m/13.3	10.1	9.3	9.2	10.0	9.8	9.3	9.7	9.6		8.5	8.8	56.0 m/8.9			54.0
	58.0			9.2	8.4		8.5	8.9	8.1	8.4	8.8	8.6	7.5	8.1	8.5			58.0
	62.0			8.3	7.7			8.0	7.3	60.0 m/7.7	7.7	7.8	7.0	5.6	7.5	7.7	64.0 m/6.4	62.0
	66.0			64.0 m/8.0	7.0			7.3	6.6		64.0 m/7.0	7.1	6.3		6.6	6.9	6.1	66.0
	70.0							6.6	5.9			6.4	5.6			6.2	5.5	70.0
	74.0								72.0 m/5.6			5.8	5.1			5.6	4.9	74.0
	78.0												4.6			4.8	4.4	78.0
	82.0																4.0	82.0
Reeves			3			2				2				2				Reeves

51.8 m Boom Length	51.8																	Boom length (m)
	21.3				27.4				33.5				39.6				Jib length (m)	
	Boom angle	88°	83°	68°	63°	88°	83°	68°	63°	88°	83°	68°	63°	88°	83°	68°	63°	Boom angle
Working Radius (m)	12.0	54.0			40.5													12.0
	14.0	52.4			40.5				40.5									14.0
	16.0	47.1			40.5				40.5				32.7					16.0
	18.0	42.6	51.8		40.5				40.5				32.3					18.0
	20.0	38.8	45.8		39.1	40.5			38.7				31.9					20.0
	22.0	35.5	40.6		35.8	40.3			35.6	39.8			31.5					22.0
	24.0	32.5	36.3		33.0	36.1			32.9	35.9			31.1	32.7				24.0
	26.0		32.9		30.5	32.6			30.6	32.5			30.2	32.2				26.0
	28.0		29.9		28.3	29.7			28.4	29.6			28.1	29.3				28.0
	30.0				25.5	27.2			26.5	27.1			26.3	26.9				30.0
	34.0			36.0 m/17.7		23.3			23.2	23.2			23.2	23.0				34.0
	38.0			16.5			40.0 m/15.1		36.0 m/19.9	20.2			20.6	19.9				38.0
	42.0			14.5	13.6		14.1		40.0 m/18.9	13.9			16.1	17.5				42.0
	46.0				12.0		12.5	11.6			12.3			15.6	12.1			46.0
	50.0						48.0 m/11.9	10.4			11.0	10.2			10.8			50.0
	54.0							52.0 m/9.9			9.9	9.2			9.7	8.8		54.0
	58.0											8.3			8.8	7.9		58.0
	62.0														60.0 m/8.4	7.2		62.0
	66.0															64.0 m/6.8		66.0
Reeves			4			3				3				3				Reeves

45.7 m Boom Length	51.8																	Boom length (m)
	45.7				51.8				57.9				61.0				Jib length (m)	
	Boom angle	88°	83°	68°	63°	88°	83°	68°	63°	88°	83°	68°	63°	88°	83°	68°	63°	Boom angle
Working Radius (m)	18.0	26.2																18.0
	20.0	25.9			21.2													20.0
	22.0	25.7			20.9				17.3				15.7					22.0
	24.0	25.4			20.6				17.0				15.4					24.0
	26.0	25.1	26.0		20.3				16.7				15.1					26.0
	28.0	24.8	25.7		20.0	20.5			16.4				14.8					28.0
	30.0	24.5	25.4		19.4	19.5			16.1	16.9			14.5	32.0 m/14.5				30.0
	34.0	22.5	22.7		17.4	17.7			14.5	15.2			13.1	13.7				34.0
	38.0	20.5	19.7		15.6	15.9			13.1	13.7			11.9	12.4				38.0
	42.0	18.0	17.3		13.9	14.3			12.0	12.4			10.9	11.3				42.0
	46.0	14.9	15.4		12.3	12.7			11.0	11.4			10.0	10.3				46.0
	50.0	48.0 m/13.0	13.8	10.6	10.7	11.3			10.1	10.4			9.2	9.5				50.0
	54.0		52.0 m/13.1	9.5	9.2	9.9	9.2		9.3	9.6			8.5	8.7				54.0
	58.0			8.5	7.6		8.5	8.2	7.3	8.7	8.0		6.3	8.1	7.8			58.0
	62.0			7.8	6.8		7.4	6.4	60.0 m/6.4	7.6	7.1		4.4	7.5	6.9			62.0
	66.0			7.1	6.1		6.7	5.8		64.0 m/7.0	6.4	5.4		5.7	6.2	68.0 m/4.9		66.0
	70.0				5.6		6.1	5.2			5.8	4.8			5.6	4.7		70.0
	74.0						72.0 m/5.8	4.6			5.2	4.3			5.0	4.2		74.0
	78.0							76.0 m/4.4			4.7	3.9			4.5	3.7		78.0
	82.0														80.0 m/4.2	3.3		82.0
	86.0															84.0 m/3.1		86.0
Reeves			2			2				2				2				Reeves

Note: Ratings according to EN13000.

Ratings shown in are determined by the strength of the boom or other structural components.

Refer to notes P25 and P26.

Unit: metric ton

**Counterweight: 90.0 t,
Carbody weight: 24.0 t**

57.9 m Boom Length	57.9																	Boom length (m)
	21.3				27.4				33.5				39.6				Jib length (m)	
	Boom angle	88°	83°	68°	63°	88°	83°	68°	63°	88°	83°	68°	63°	88°	83°	68°	63°	Boom angle
Working Radius (m)	12.0	40.5																12.0
	14.0	38.4				39.5				37.2								14.0
	16.0	35.4				35.7				35.5				27.0				16.0
	18.0	33.0	40.5			32.4				32.3				27.0				18.0
	20.0	30.0	37.3			29.6	36.3			29.6				27.0				20.0
	22.0	27.5	33.7			27.2	33.0			27.2	32.8			27.0				22.0
	24.0	25.2	30.7			25.1	30.2			25.1	30.1			25.0	27.0			24.0
	26.0		28.0			23.3	27.7			23.3	27.6			23.2	27.0			26.0
	28.0		25.7			21.6	25.5			21.7	25.5			21.6	25.3			28.0
	30.0		23.6			20.1	23.6			20.2	23.6			20.1	23.5			30.0
	34.0						20.4			17.7	20.5			17.7	20.4			34.0
	38.0			15.8			36.0 m/19.0			36.0 m/16.5	17.9			15.6	17.9			38.0
	42.0			13.8	44.0 m/11.8			13.6			15.7			13.8	15.8			42.0
	46.0			44.0 m/13.0	11.2			12.0	48.0 m/10.2			11.7		14.0	48.0 m/10.7			46.0
	50.0				48.0 m/10.5			10.8	9.7			10.4	52.0 m/8.8		10.1			50.0
	54.0								8.7			9.4	8.3			9.1	56.0 m/7.4	54.0
	58.0											56.0 m/8.9	7.4			8.2	7.0	58.0
	62.0												60.0 m/7.0			7.4	6.3	62.0
	66.0																5.7	66.0
Reeves				3				3				3				2		Reeves

57.9 m Boom Length	57.9																	Boom length (m)
	45.7				51.8				57.9				61.0				Jib length (m)	
	Boom angle	88°	83°	68°	63°	88°	83°	68°	63°	88°	83°	68°	63°	88°	83°	68°	63°	Boom angle
Working Radius (m)	18.0	24.5																18.0
	20.0	24.2				20.0												20.0
	22.0	23.9				19.7				16.4				14.9				22.0
	24.0	23.6				19.4				16.2				14.7				24.0
	26.0	23.1	24.3			19.1				16.0				14.5				26.0
	28.0	21.5	24.0			18.8				15.8				14.3				28.0
	30.0	20.0	22.8			18.5	19.3			15.6	32.0 m/16.0			14.1	32.0 m/14.4			30.0
	34.0	17.6	19.8			17.2	17.4			14.4	15.1			13.0	13.7			34.0
	38.0	15.6	17.5			15.4	15.7			13.1	13.6			11.8	12.3			38.0
	42.0	13.8	15.5			13.8	14.1			11.9	12.4			10.8	11.2			42.0
	46.0	12.4	13.9			12.2	12.6			10.9	11.3			9.9	10.2			46.0
	50.0	48.0 m/11.7	12.4	52.0 m/9.3		10.6	11.1			10.0	10.3			9.1	9.4			50.0
	54.0		52.0 m/11.8	8.8		9.2	9.8	56.0 m/7.9		7.9	9.5			7.0	8.6			54.0
	58.0			7.9	60.0 m/6.5		8.5	7.5		6.0	8.5	60.0 m/6.8		5.0	8.0			58.0
	62.0			7.1	6.1			6.7	64.0 m/5.2	60.0 m/5.1	7.5	6.4		3.3	6.8	6.2		62.0
	66.0			6.4	5.5			6.0	4.9		64.0 m/6.4	5.7	68.0 m/4.3		4.7	5.5		66.0
	70.0			68.0 m/6.1	5.0			5.4	4.4			5.1	4.0		68.0 m/3.7	4.9	3.9	70.0
	74.0				72.0 m/4.7			4.9	3.9			4.6	3.6			4.4	3.4	74.0
	78.0											4.1	3.2			3.9	3.0	78.0
	82.0											80.0 m/3.9	2.8			3.5	2.6	82.0
	86.0												84.0 m/2.6					86.0
Reeves				2				2				2				2		Reeves

Note:
Ratings according to EN13000.
Ratings shown in are determined by the strength of the boom or other structural components.
Refer to notes P25 and P26.

Unit: metric ton

Counterweight: 90.0 t,
Carbody weight: 24.0 t

61.0 m Boom Length	61.0																
	30.5				33.5				39.6				45.7				
	88°	83°	68°	63°	88°	83°	68°	63°	88°	83°	68°	63°	88°	83°	68°	63°	
Working Radius (m)	14.0	35.0			27.0				27.0								14.0
	16.0	31.6			27.0				27.0								16.0
	18.0	28.7			27.0				27.0				23.6				18.0
	20.0	26.2			26.1				26.0				23.3				20.0
	22.0	24.1	29.4		24.0				23.8				23.0				22.0
	24.0	22.2	26.9		22.1	25.8			22.0				21.8				24.0
	26.0	20.6	24.6		20.5	23.8			20.4	23.6			20.2				26.0
	28.0	19.1	22.7		19.0	22.0			18.9	21.8			18.8	21.6			28.0
	30.0	17.8	21.0		17.7	20.4			17.6	20.2			17.5	20.1			30.0
	34.0	15.5	18.1		15.5	17.7			15.4	17.6			15.3	17.5			34.0
	38.0		15.7		36.0 m/14.5	15.5			13.6	15.4			13.5	15.3			38.0
	42.0			44.0 m/12.2		13.7			12.0	13.6			12.0	13.5			42.0
	46.0			11.5			11.2			12.1			10.7	12.1			46.0
	50.0			10.2	52.0 m/8.5		10.0			48.0 m/11.4	9.7		48.0 m/10.1	10.8			50.0
	54.0			9.2	8.0		9.0	7.9			8.7			9.6	8.3		54.0
	58.0				7.1		8.1	7.1			7.8	6.7			7.4		58.0
	62.0				60.0 m/6.8			6.4			7.0	6.0			6.7	5.6	62.0
	66.0											5.4			6.0	5.0	66.0
	70.0												68.0 m/5.1		68.0 m/5.7	4.5	70.0
	74.0															4.1	74.0
Reeves			3				2				2				2		Reeves

61.0													
51.8				57.9				61.0					
88°	83°	68°	63°	88°	83°	68°	63°	88°	83°	68°	63°		
20.0	19.4												20.0
22.0	19.1			15.9				14.5					22.0
24.0	18.8			15.7				14.3					24.0
26.0	18.5			15.5				14.1					26.0
28.0	17.5			15.3				13.9					28.0
30.0	16.4	18.6		15.1	32.0 m/15.5			13.7	32.0 m/14.1				30.0
34.0	14.5	16.4		13.5	14.6			13.0	13.6				34.0
38.0	12.9	14.5		12.2	13.0			11.8	12.3				38.0
42.0	11.6	12.9		11.0	11.7			10.7	11.1				42.0
46.0	10.4	11.5		10.0	10.7			9.8	10.2				46.0
50.0	9.5	10.3		9.0	9.7			8.4	9.3				50.0
54.0	8.6	9.3	56.0 m/7.5	7.1	8.9			6.3	8.6				54.0
58.0		8.4	7.1	5.3	8.2	60.0 m/6.3		4.4	7.9				58.0
62.0		60.0 m/7.7	6.3	60.0 m/4.4	6.5	6.0		2.8	6.2	5.8			62.0
66.0			5.6	4.4		4.8	5.3		4.2	5.1			66.0
70.0			5.0	3.9			4.7	3.6	68.0 m/3.2	4.6	72.0 m/3.2		70.0
74.0			4.5	3.5			4.2	3.2		4.0	3.0		74.0
78.0				3.1			3.8	2.8		3.6	76.0 m/2.8		78.0
82.0				80.0 m/2.9			80.0 m/3.6			3.2			82.0
Reeves			2				2			2			Reeves

Note:
Ratings according to EN13000.
Ratings shown in are determined by the strength of the boom or other structural components.
Refer to notes P25 and P26.



Luffing Boom Lifting Capacities with Luffing Jib

Attached at 23 Degree Boom to Luffing Jib Offset Angle

Unit: metric ton

Counterweight: 90.0 t,
Carbody weight: 24.0 t

21.3 m Boom Length	Boom length (m)	21.3					
	Jib length (m)	21.3	30.5	39.6	48.8	57.9	61.0
	6.4 m	125.0	119.0	114.1	107.5	100.3	97.2
	7.0 m	125.0	119.0	114.1	107.5	100.3	97.2
	8.0 m	125.0	119.0	114.1	107.5	100.3	97.2
	9.0 m	111.7	106.6	102.7	97.3	91.6	89.1
	10.0 m	99.3	94.5	90.7	85.7	80.3	77.9
	12.0 m	72.6	68.2	64.8	61.2	55.2	53.0
	14.0 m	55.3	51.3	48.0	44.7	39.1	37.2
	16.0 m	43.9	40.1	37.0	33.8	28.6	26.8
	18.0 m	35.7	32.2	29.1	26.1	21.2	19.5
	Reeves	10	10	10	8	8	8

30.5 m Boom Length	Boom length (m)	30.5					
	Jib length (m)	21.3	30.5	39.6	48.8	57.9	61.0
	8.0 m	115.2	111.6	106.5	101.4	95.8	93.4
	9.0 m	107.3	103.9	99.3	94.5	89.3	87.1
	10.0 m	95.7	92.5	88.1	83.7	78.8	76.7
	12.0 m	72.9	70.0	66.0	62.0	57.6	55.7
	14.0 m	55.6	53.0	49.3	45.5	41.5	39.7
	16.0 m	44.0	41.6	38.1	34.5	30.7	29.1
	18.0 m	35.7	33.4	30.1	27.5	23.1	21.6
	20.0 m	29.3	27.1	23.9	21.4	17.2	15.8
	22.0 m	24.2	22.2	19.0	16.7	12.6	11.2
	24.0 m	20.2	18.2	15.1	12.9	9.0	7.7
	Reeves	10	10	8	8	8	7

36.6 m Boom Length	Boom length (m)	36.6					
	Jib length (m)	21.3	30.5	39.6	48.8	57.9	61.0
	10.0 m	93.5	89.2	84.6	80.3	75.8	73.8
	12.0 m	74.5	70.6	66.4	62.6	58.5	56.7
	14.0 m	57.1	53.5	49.7	46.2	42.3	40.7
	16.0 m	45.5	42.1	38.5	35.1	31.6	30.0
	18.0 m	37.1	33.9	30.4	27.3	23.9	22.4
	20.0 m	30.6	27.5	24.2	21.2	18.0	16.6
	22.0 m	25.5	22.5	19.3	16.4	13.3	12.0
	24.0 m	21.3	18.4	15.3	12.6	9.6	8.3
	26.0 m	18.0	15.2	12.2	9.5	6.6	
	28.0 m	15.1	12.4	9.5	7.5		
	30.0 m	12.9	10.2	7.4	5.5		
	Reeves	7	7	7	6	6	6

42.7 m Boom Length	Boom length (m)	42.7					
	Jib length (m)	21.3	30.5	39.6	48.8	57.9	61.0
	12.0 m	71.6	67.5	63.5	59.9	55.9	54.2
	14.0 m	57.3	53.5	49.8	46.5	42.9	41.3
	16.0 m	45.7	42.1	38.6	35.5	32.1	30.6
	18.0 m	37.2	33.8	30.6	27.6	24.4	23.0
	20.0 m	30.6	27.4	24.2	21.4	18.3	17.0
	22.0 m	25.3	22.2	19.2	16.5	13.6	12.3
	24.0 m	21.2	18.2	15.2	12.6	9.8	8.6
	26.0 m	17.8	14.9	12.0	9.5	6.8	
	28.0 m	14.9	12.1	9.3	6.9		
	30.0 m	12.5	9.8	7.1	5.2		
	32.0 m	10.5	7.8	5.2			
	34.0 m	8.7	6.1				
	Reeves	6	6	5	5	5	5

48.8 m Boom Length	Boom length (m)	48.8					
	Jib length (m)	21.3	30.5	39.6	48.8	57.9	61.0
	12.0 m	65.4	61.7	57.8	54.0	49.3	47.3
	14.0 m	55.8	52.5	48.5	46.2	41.8	40.3
	16.0 m	45.5	42.4	38.7	36.6	32.4	31.0
	18.0 m	37.1	34.2	30.6	28.6	24.7	23.4
	20.0 m	30.4	27.7	24.3	22.4	18.7	17.4
	22.0 m	25.2	22.5	19.3	17.4	13.9	12.6
	24.0 m	21.0	18.4	15.3	13.5	10.1	8.9
	26.0 m	17.6	15.1	12.1	10.3	7.0	
	28.0 m	14.7	12.2	9.3	7.6		
	30.0 m	12.3	9.9	7.0	5.4		
	32.0 m	10.2	7.8	5.1			
	34.0 m	8.4	6.1				
	36.0 m	6.9					
	38.0 m	5.5					
	Reeves	5	5	5	5	4	4

54.9 m Boom Length	Boom length (m)	54.9					
	Jib length (m)	21.3	30.5	39.6	48.8	57.9	61.0
	14.0 m	51.2	47.7	44.6	41.6	37.3	35.8
	16.0 m	44.4	41.1	38.3	35.4	31.4	30.0
	18.0 m	37.1	34.0	31.3	28.6	24.8	23.5
	20.0 m	30.4	27.4	24.9	22.3	18.7	17.5
	22.0 m	25.2	22.3	19.8	17.4	13.9	12.7
	24.0 m	21.0	18.2	15.8	13.4	10.1	9.0
	26.0 m	17.5	14.7	12.5	10.2	7.0	5.9
	28.0 m	14.6	12.0	9.8	7.5		
	30.0 m	12.1	9.5	7.4	5.2		
	32.0 m	10.0	7.5	5.4			
	34.0 m	8.2	5.7				
	36.0 m	6.6					
	38.0 m	5.2					
	Reeves	4	4	4	4	3	3

61.0 m Boom Length	Boom length (m)	61.0				
	Jib length (m)	30.5	39.6	48.8	57.9	61.0
	14.0 m	46.2	43.6	40.0	35.8	34.3
	16.0 m	38.4	35.6	32.8	28.9	27.6
	18.0 m	32.6	30.0	27.4	23.7	22.4
	20.0 m	27.2	24.7	22.2	18.7	17.5
	22.0 m	22.1	19.7	17.4	14.0	12.9
	24.0 m	17.9	15.6	13.3	10.1	9.0
	26.0 m	14.6	12.3	10.2	7.0	6.0
	28.0 m	11.7	9.6	7.4		
	30.0 m	9.3	7.2	5.1		
	32.0 m	7.3	5.2			
	34.0 m	5.5				
	Reeves	4	4	3	3	3

Note: Ratings according to EN13000.

Ratings shown in are determined by the strength of the boom or other structural components.

Refer to notes P25 and P26.

PARTS AND ATTACHMENTS

Dimensions: mm Weight: kg

Base Machine

With trans-lifter, main and aux. winches (non-free fall) including wire rope and boom hoist winch including wire rope
Weight: 46,000 kg Width: 3,400 mm

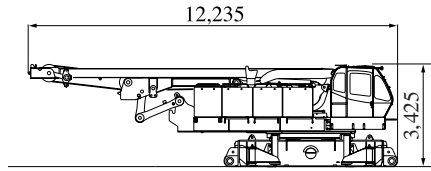

Crawler

Weight: 20,700 kg

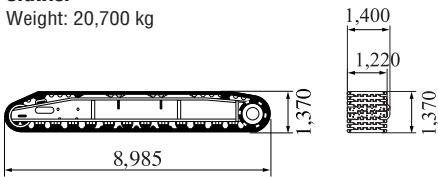

Mast

Weight: 2,870 kg

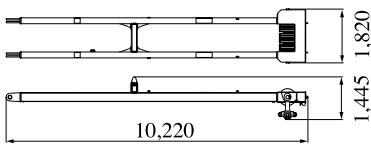

Gantry

Weight: 3,020 kg

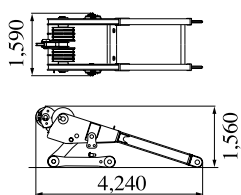

Translifter

Weight: 395 kg

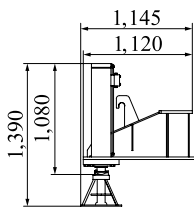

Boom Base

Weight: 4,665 kg

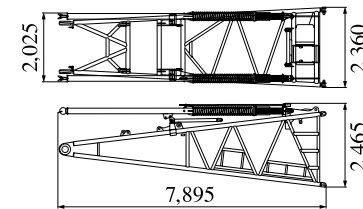

Boom Base (with Winch)

Weight: 6,810 kg

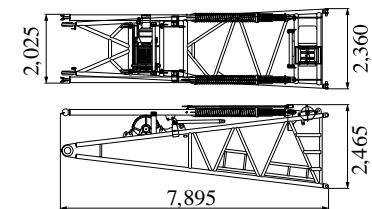

3.0 m Insert Boom (with Guy Line)

Weight: 890 kg

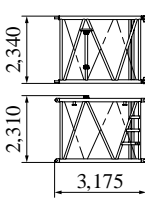

Boom Top

Weight: 3,740 kg (with boom guy cables)

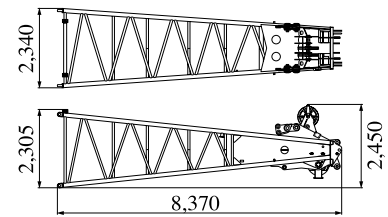

6.1 m Insert Boom (with Guy Line)

Weight: 1,440 kg

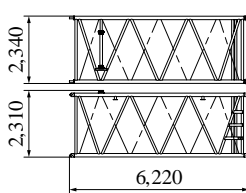

12.2 m Insert Boom (with Guy Line)

Weight: 2,540 kg

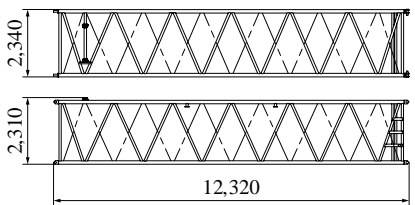

Jib Base (Fixed Jib)

Weight: 210 kg

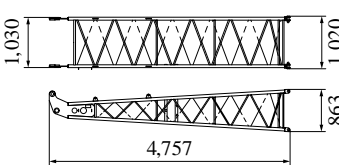

Jib Strut (Fixed Jib)

Weight: 300 kg

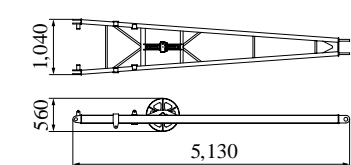

Counterweight (A) with Hanger

Weight: 11,040 kg

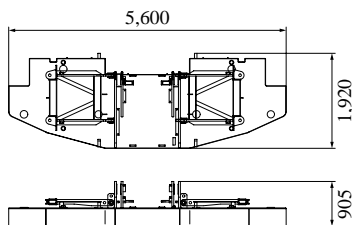

Counterweight (B)

Weight: 5,685 kg / 1 Piece

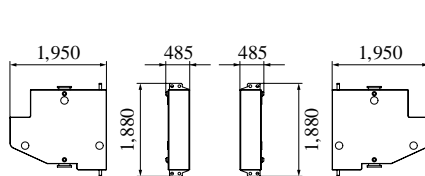

Counterweight Assy

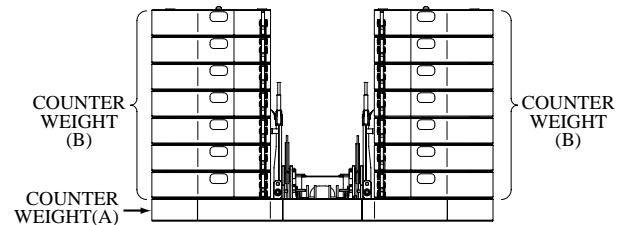

Carbody Weight (Base) (with Link)

Weight: 6,350 kg x 1 piece

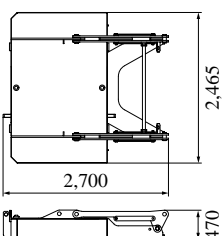

Carbody Weight (B)

Weight: 5,625 kg

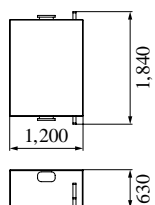

Carbody Weight Assy

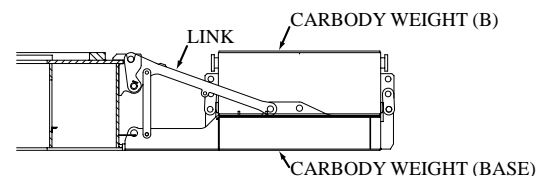

Dimensions: mm Weight: kg

Jib Top (For Crane)

Weight: 315 kg

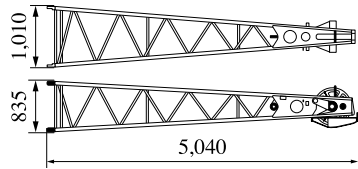

Luffing Tapered Boom

Weight: 1,190 kg

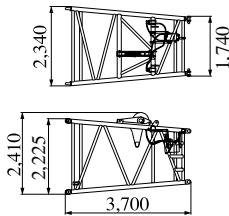

Front Strut (Luffing Jib)

Weight: 1,410 kg

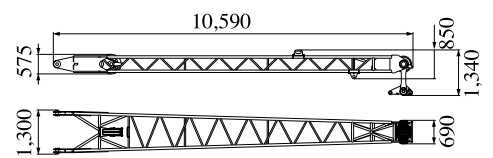

Travel Kit Assembly

Weight: 6,730 kg

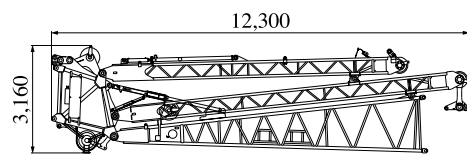

Luffing Jib Base

Weight: 1,470 kg

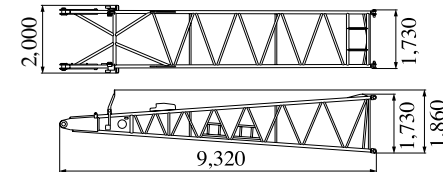

Rear Strut (Luffing Jib)

Weight: 1,510 kg

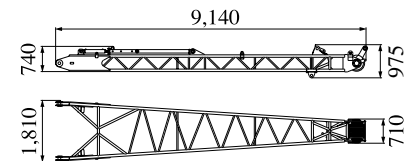

Luffing Boom Top

Weight: 2,085 kg

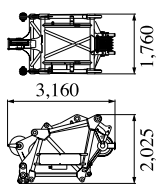

Luffing Jib Top

Weight: 1,400 kg

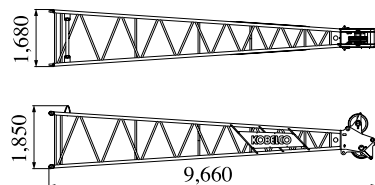

3.0 m Special Insert Jib (Luffing Jib)

Weight: 313 kg

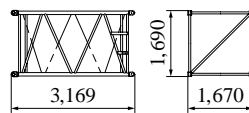

Aux. Sheave

Weight: 290 kg

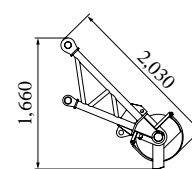

Aux. Sheave (For Luffing Jib)

Weight: 380 kg

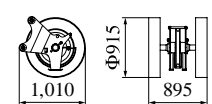

3.0 m Insert Jib (Fixed Jib)

Weight: 110 kg

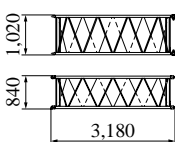

6.1 m Insert Jib (Fixed Jib)

Weight: 190 kg

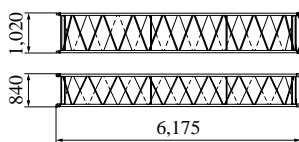

Luffing Jib Backstop

Weight: 260 kg

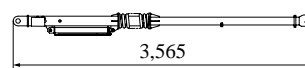

Strut Backstop (Luffing Jib)

Weight: 180 kg

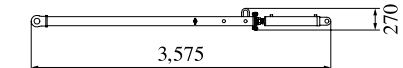

3.0 m Insert Jib (Luffing Jib)

Weight: 320 kg

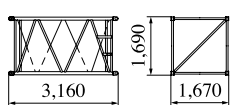

6.1 m Insert Jib (Luffing Jib)

Weight: 530 kg

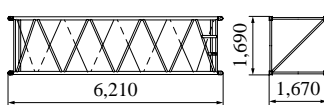

12.2 m Insert Jib (Luffing Jib)

Weight: 960 kg

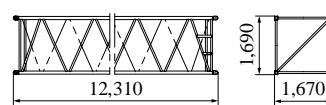

Ball Hook

Weight: 455 kg

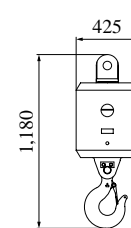

35 t Hook

Weight: 900 kg

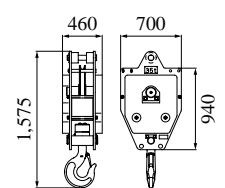

70 t Hook

Weight: 1,200 kg

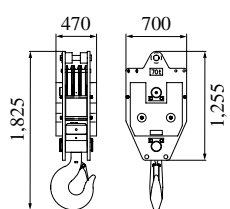

100 t Hook

Weight: 1,800 kg

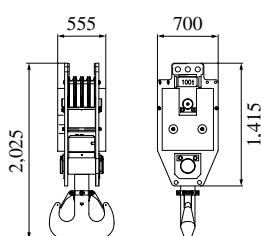

150 t Hook

Weight: 2,300 kg

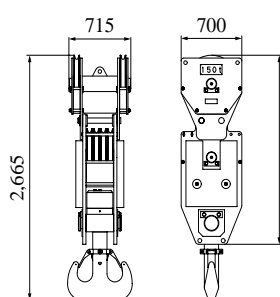

260 t Hook

Weight: 4,160 kg

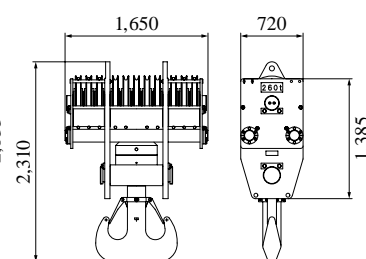

Other Attachments

Attachments	Weight	Dimensions (L x W x H)
Relay jib	400 kg (with guy cables)	3,170 mm x 1,670 mm x 1,690 mm
Tapered boom with idler sheave & link (for long)	1,170 kg	4,905 mm x 2,340 mm x 2,360 mm
Luffing jib drum	2,050 kg (with wire rope)	1,780 mm x 1,190 mm x 1,040 mm

Note: Estimated weights may vary ± 2%.

TRANSPORTATION PLAN

Luffing Boom 61.0 m + Luffing Jib 61.0 m

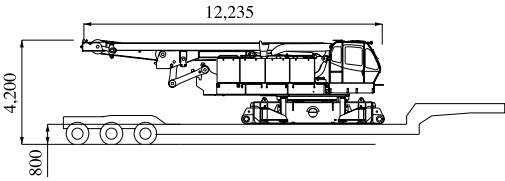
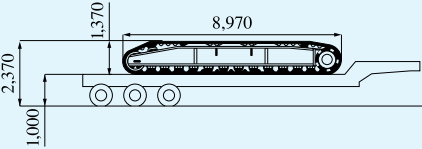
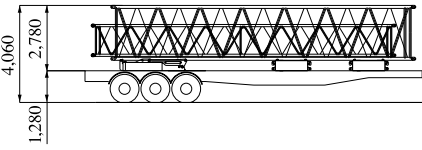
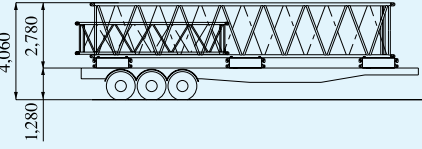
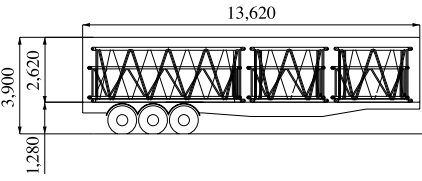
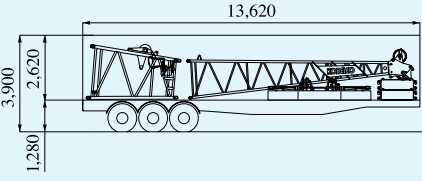
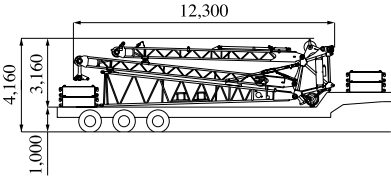
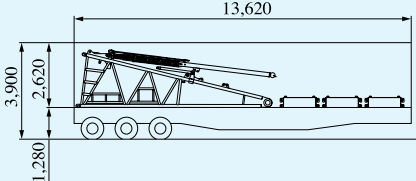
Configuration	Description	Total Weight
No.1 Low Loader 	Base Machine = With trans-lifter, main and aux. winches (non-free fall) including wire rope, boom hoist winch including wire rope	46.00 ton
No.2 Semi Loader 	Crawler = (2 x 20.7 ton)	41.40 ton
No.3 & No.4 Flat Bed Trailer 	Carbodyweight A x 1 = Counterweight (2 x 5.63 ton) = 12.2 m Insert Boom x 1 = 12.2 m Luffing Insert Jib x 1 = Total =	6.35 ton 11.26 ton 2.54 ton 1.17 ton 21.32 ton
No.5 Flat Bed Trailer 	Counterweight (3 x 5.63 ton) = 12.2 m Insert Boom x 1 = 6.1 m Luffing Insert Jib x 1 = Total =	16.89 ton 2.54 ton 0.67 ton 20.10 ton
No.6 Tent Side Truck 	3.0 m Insert Boom (2 x 0.89 ton) = 6.1 m Insert Boom x 1 = 6.1 m Luffing Insert Jib x 1 = 3.0 m Luffing Insert Jib x 1 = Relay Jib x 1 = Total =	1.78 ton 1.44 ton 0.67 ton 0.42 ton 0.40 ton 4.71 ton
No.7 Tent Side Truck 	Luffing Jib Top x 1 = Luffing Tapered Boom x 1 = Counterweight (2 x 5.63 ton) = Counterweight A x 1 = Total =	1.40 ton 1.19 ton 11.26 ton 11.04 ton 24.89 ton
No.8 Semi Loader 	Travel Kit Assembly = Counterweight (2 x 5.63 ton) = Carbodyweight B (2 x 5.63 ton) = Total =	6.73 ton 11.26 ton 11.26 ton 29.25 ton
No.9 Tent Side Truck 	Boom Base x 1 = Counterweight (3 x 5.63 ton) = Total =	6.81 ton 16.89 ton 23.70 ton

Note: Estimated weights may vary $\pm 2\%$.

This transportation plan depends on specifications of your trailers/trucks and the areas or countries where you transport.

SELF-REMOVAL DEVICE

1

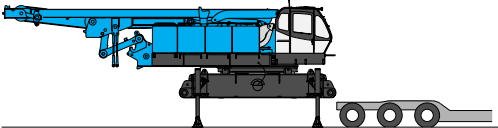

2

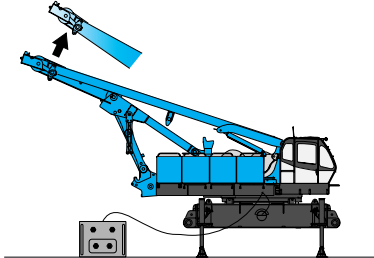

3

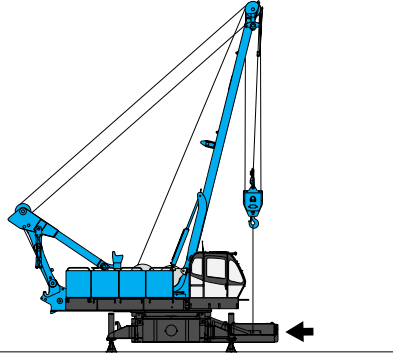

4

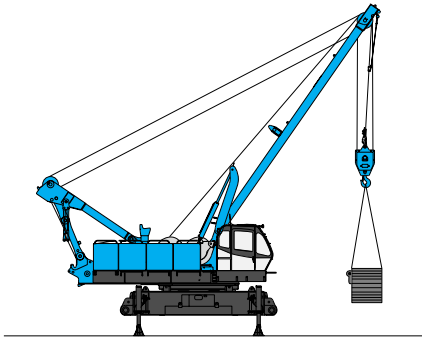

5

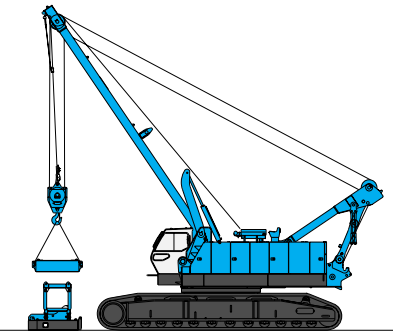

6

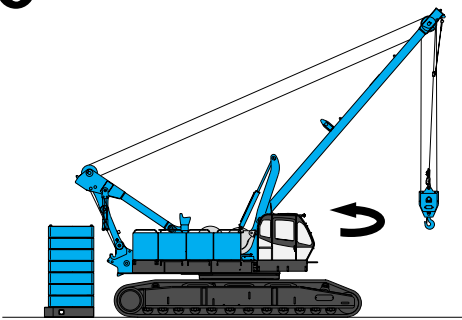

7

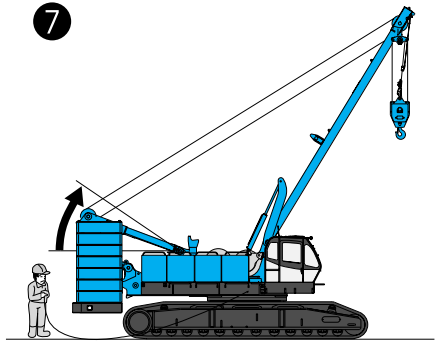

8

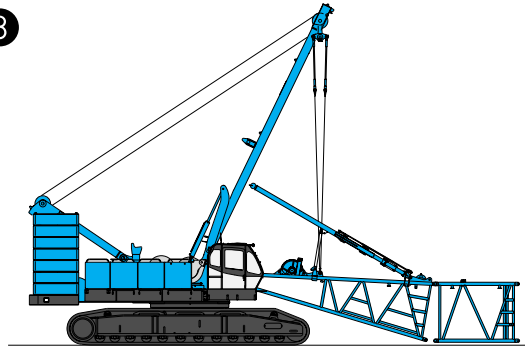



HYDRAULIC CRAWLER CRANE
CKL2600i

Standard Equipment

Upper structure/Lower structure

Counterweight: 90.0 ton (total weight)
 Carbody weight: 24.0 ton (total weight)
 1,220 mm shoe crawlers
 Batteries (150Ah/20HR)
 Trans-lifter (jack system)
 Gantry raising/lowering cylinder
 Electric hand throttle grip
 Variable boom hoist speed controller
 Variable main/aux. hoist speed controller
 Swing neutral-free/brake select switch
 Side deck for cab
 Side deck (right side guard)
 Steps (crawlers)
 Two front working lights
 Tools (for routine maintenance)
 Two rear view mirrors
 Electric fuel pump
 Counterweight self removal
 Crawler self removal
 Base boom self removal
 Cable roller (for boom)

Cab/Control

Air conditioner
 Cup holder
 Ashtray
 Cigar lighter
 Intermittent wiper & window washer (skylight and front window)
 Sun visor
 Roof blind
 Floor mat (cloth)
 Foot rest
 Shoe tray

Safety Device

Load Moment Indicator (with boom lowering slow stop function)
 LMI release key (for hook over-hoist prevention device and boom over-hoist prevention device)
 LCD multi display
 Ultimate stop function for boom over-hoist
 Function lock lever
 Propel lever lock
 Mechanical drum lock pawl (main, aux. and boom hoist)
 Signal horn
 Swing parking brake
 Mechanical swing lock pin (four positions)
 Swing flashers/warning buzzer
 External lamp for over-load alarm

Note: Standard equipment may vary depending on your areas or countries.
 Due to our policy of continual product improvements all designs and specifications are subject to change without advance notice.
 Copyright by KOBELCO CRANES CO., LTD. No part of this catalog may be reproduced in any manner without notice.

KOBELCO CRANES INDIA PVT. LTD.

H-200, Sector-63, Noida,
 Distt: Gautam Budh Nagar, Uttar Pradesh-201, 307, India
 Tel: +91-120-407-9989 Fax: +91-120-407-9990

Inquiries To:

KOBELCO is the corporate mark used by Kobe Steel on a variety of products and in the names of a number of Kobe Steel Group companies.